

MiniRAE Lite User's Guide



MiniRAE Lite User's Guide

Contents

1	Standard Contents.....	7
2	General Information.....	7
3	Physical Description.....	8
4	Specifications.....	8
5	Replacing Alkaline Batteries.....	11
6	Charging A Lithium Ion Battery.....	13
7	Charging A Spare Rechargeable Battery.....	14
	Low Voltage Warning.....	15
	Clock Battery.....	15
8	User Interface.....	16
9	Display.....	18
10	Operating The Instrument.....	19
11	Turning The Instrument On.....	19
12	Turning The Instrument Off.....	20
13	Operating The Built-In Flashlight.....	20
14	Pump Status.....	20
15	Calibration Status.....	21
16	Basic Operation.....	22
17	Alarm Signals.....	23
18	Preset Alarm Limits & Calibration.....	24
19	Testing The Alarm.....	24
20	Integrated Sampling Pump.....	24
21	Backlight.....	25
22	Standard Accessories.....	25
23	Standard Kit & Accessories.....	25
	Alkaline Battery Adapter.....	25
	To insert batteries into the adapter:.....	25
24	External Filter.....	26
25	Optional Accessories.....	27
	Calibration Adapter.....	27
	Calibration Regulator.....	27
	Organic Vapor Zeroing Kit.....	27
	Travel Charger.....	27
26	Standard Two-Point Calibration (Zero & Span).....	29
	Entering Calibration.....	30
	Zero (Fresh Air) Calibration.....	31
	Span Calibration.....	33
	Exiting Two-Point Calibration.....	35

MiniRAE Lite User's Guide

27	Programming Mode	35
	Entering Programming Mode.....	35
28	Programming Mode Menus	37
	Exiting Programming Mode.....	38
	Navigating Programming Mode Menus.....	38
29	Key Function in Programming Mode	38
	Calibration.....	39
	Zero Calibration.....	39
	Span Calibration	39
	Alarm Setting	40
	High Alarm	41
	Low Alarm.....	41
	Alarm Type.....	42
	Buzzer & Light	44
	Language	45
	Power On Zero.....	46
	LCD Contrast.....	46
	Diagnostic Mode	47
	Entering Diagnostic Mode.....	47
	Adjusting The Pump Stall Threshold	48
	Pump High.....	48
	Pump Low.....	48
	Exiting Diagnostic Mode.....	49
30	Updating Firmware From A Computer	50
31	Maintenance.....	51
	Battery Charging & Replacement	51
	Replacing The Li-ion Battery Or Alkaline Adapter	52
	PID Sensor & Lamp Cleaning/Replacement.....	54
	Cleaning The PID Sensor.....	55
	Cleaning The Lamp Housing Or Changing The Lamp.....	55
	Sampling Pump.....	57
	Cleaning The Instrument	57
	Ordering Replacement Parts	57
	Special Servicing Note.....	58
32	Troubleshooting.....	59
33	Technical Support.....	60
34	RAE Systems Contacts	61
	Controlled Part of Manual.....	64

MiniRAE Lite User's Guide

Read Before Operating

This manual must be carefully read by all individuals who have or will have the responsibility of using, maintaining, or servicing this product. The product will perform as designed only if it is used, maintained, and serviced in accordance with the manufacturer's instructions. The user should understand how to set the correct parameters and interpret the obtained results.

CAUTION!

To reduce the risk of electric shock, turn the power off before removing the instrument cover. Disconnect the battery before removing sensor module for service. Never operate the instrument when the cover is removed. Remove instrument cover and sensor module only in an area known to be non-hazardous.

Special Notes



When the instrument is taken out of the transport case and turned on for the first time, there may be some residual organic or inorganic vapor trapped inside the detector chamber. The initial PID sensor reading may indicate a few ppm. Enter an area known to be free of any organic vapor and turn on the instrument. After running for several minutes, the residual vapor in the detector chamber will be cleared and the reading should return to zero.



The battery of the instrument discharges slowly even if it is turned off. If the instrument has not been charged for 5 to 7 days, the battery voltage will be low. Therefore, it is a good practice to always charge the instrument before using it. It is also recommended to fully charge the instrument for *at least 10 hours* before first use. Refer to this User Guide's section on battery charging for more information on battery charging and replacement.

WARNINGS

STATIC HAZARD: Clean only with damp cloth.

For safety reasons, this equipment must be operated and serviced by qualified personnel only. Read and understand instruction manual completely before operating or servicing.

Use only a RAE Systems battery pack, part number 059-3051-000, 059-3052-000, or 059-3054-000. This instrument has not been tested in an explosive gas/air atmosphere having an oxygen concentration greater than 21%. Substitution of components may impair intrinsic safety. Recharge/replace batteries only in non-hazardous locations.

Do not mix old and new batteries or batteries from different manufacturers.

The calibration of all newly purchased RAE Systems instruments should be tested by exposing the sensor(s) to known concentration calibration gas before the instrument is put into service.

For maximum safety, the accuracy of the instrument should be checked by exposing it to a known concentration calibration gas before each day's use.

Do not use USB/PC communication in hazardous locations.

AVERTISSEMENT

DANGER RISQUE D'ORIGINE ELECTROSTATIQUE:

Nettoyer uniquement avec un chiffon humide.

Pour des raisons de sécurité, cet équipement doit être utilisé, entretenu et réparé uniquement par un personnel qualifié. Étudier le manuel d'instructions en entier avant d'utiliser, d'entretenir ou de réparer l'équipement.

Utiliser seulement l'ensemble de batterie RAE Systems, la référence 059-3051-000 au 059-3052-000 au 059-3054-000. Cet instrument n'a pas été essayé dans une atmosphère de gaz/air explosive ayant une concentration d'oxygène plus élevée que 21%. La substitution de composants peut compromettre la sécurité intrinsèque. Ne charger les batteries que dans emplacements désignés non-dangereuse.

Ne pas mélanger les anciennes et les nouvelles batteries, ou bien encore les batteries de différents fabricants.

La calibration de tous les instruments de RAE Systems doit être testée en exposant l'instrument à une concentration de gaz connue par une procédure de tarage avant de mettre en service l'instrument pour la première fois.

Pour une sécurité maximale, la sensibilité de l'instrument doit être vérifiée en exposant l'instrument à une concentration de gaz connue par une procédure de tarage avant chaque utilisation journalière.

Ne pas utiliser de connexion USB/PC en zone dangereuse.

1 Standard Contents

Instrument
Calibration Kit
Travel Charger
AC/DC Adapter
Alkaline Battery Adapter
User's Guide

2 General Information

The compact instrument is designed as a broadband VOC gas monitor to work in non-hazardous environments. It monitors Volatile Organic Compounds (VOC) using a photoionization detector (PID) with a 10.6 eV gas-discharge lamp. Features are:

Lightweight and Compact

- Compact, lightweight, rugged design
- Built-in sample draw pump

Dependable and Accurate

- Up to 16 hours of continuous monitoring with rechargeable battery pack
- Designed to continuously monitor VOC vapor at parts-per-million (ppm) levels

User-friendly

- Preset alarm thresholds for low- and high-level peak values.
- Audio buzzer and flashing LED display are activated when the limits are exceeded.

The instrument consists of a PID with associated microcomputer and electronic circuit. The unit is housed in a rugged case with a backlit LCD and 3 keys to provide easy user interface. It also has a built-in flashlight for operational ease in dark locations.

3 Physical Description

The main components of the portable VOC monitoring instrument include:

- Three keys for user to interact with the instrument:
3 operation/programming keys for normal operation or programming
- LCD display with back light for direct readout and calculated measurements
- Built-in flashlight for illuminating testing points in dark environments
- Buzzer and red LEDs for alarm signaling whenever exposures exceed preset limits
- Charge contacts for plugging directly to its charging station
- Gas entry and exit ports
- USB communication port for PC interface
- Protective rubber cover

4 Specifications

Size:	9.25" L x 3.6" W x 2.9" H
Weight:	28 oz with battery pack
Detector:	Photoionization sensor with 10.6 eV UV lamp
Battery:	Rechargeable Lithium-Ion battery pack (snap in, field replaceable) Alkaline battery holder (for 4 AA batteries)
Battery Charging:	Less than 8 hours to full charge
Operating Hours:	Up to 16 hours continuous operation
Display:	Large dot matrix screen with backlight

MiniRAE Lite User's Guide

Measurement range & resolution

Lamp	Range	Resolution
10.6 eV	0.1 ppm to 5,000 ppm	0.1 ppm

Response time (T_{90}): 2 seconds

Accuracy (Isobutylene): 10 to 2000 ppm: $\pm 5\%$ at calibration point.

PID Detector: Easy access to lamp and sensor for cleaning and replacement

Calibration: Two-point field calibration of zero and standard reference gases

Inlet Probe: Flexible 5" tubing

Keypad: 1 operation key and 2 programming keys; 1 flashlight switch

Direct Readout: Instantaneous, peak value, and battery voltage

Intrinsic Safety: US and Canada: Class I, Division 1, Groups A, B, C, D
Europe: ATEX (0575 Ex II 2G Ex ia IIC/IIB T4 Gb)
KEMA 07 ATEX 0127
Complies with EN60079-0:2009, EN60079-11:2007
IECEX CSA 10.0005 Ex ia IIC/IIB T4 Gb
Complies with IEC 60079-0:2007, IEC 60079-11:2006
(IIC: 059-3051-000 Li-ion bat pack
or 059-3054-000 NiMH bat pack;
IIB: 059-3052-000 alkaline bat pack)

EM Interference: Highly resistant to EMI/RFI.

MiniRAE Lite User's Guide

Alarm Setting:	Separate alarm limit settings for Low Alarm and High Alarm
Alarm:	Buzzer 95dB at 30cm and flashing red LEDs to indicate exceeded preset limits, low battery voltage, or sensor failure
Alarm Type:	Latching or automatic reset
Real-time Clock:	Automatic date and time
Communication:	Download instrument setup from PC via RS-232 with Travel Charger, or via USB with optional Charger Stand
Sampling Pump:	Internally integrated. Flow rate: 450 to 550 cc/min.
Temperature:	-20° C to 50° C (-4° to 122° F)
Humidity:	0% to 95% relative humidity (non-condensing)
Housing (including rubber boot):	Polycarbonate, splashproof and dustproof Battery can be changed without removing rubber boot.

5 Replacing Alkaline Batteries

An alkaline battery adapter is supplied with each instrument. The adapter (part number 059-3052-000) accepts four AA alkaline batteries (use only Duracell MN1500) and provides approximately 12 hours of operation. (An optional rechargeable lithium-ion battery pack, part number 059-3051-000, is also available.)

To install the adapter in the instrument:

1. Remove the alkaline battery adapter from the instrument by sliding the tab and tilting out the adapter.

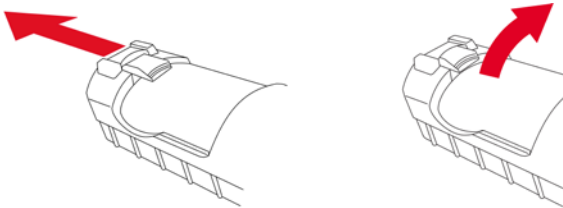

2. Replace the batteries (follow the procedure below).
3. Tilt the alkaline battery adapter and put it into the instrument.
4. Slide the tab back into place to secure the battery adapter.

To insert batteries into the adapter:

1. Remove the three Philips-head screws to open the compartment in the adapter.

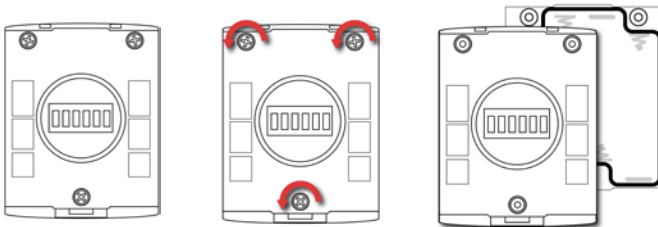

MiniRAE Lite User's Guide

2. Insert four fresh AA batteries as indicated by the polarity (+/-) markings.

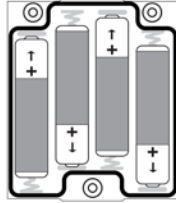

3. Replace the cover. Replace the three screws.

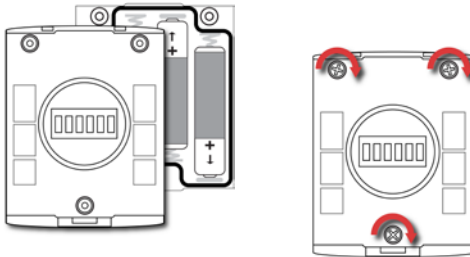

IMPORTANT!

Alkaline batteries cannot be recharged. The instrument's internal circuit detects alkaline batteries and will not allow recharging. If you place the instrument in its Travel Charger or Charger Stand, the alkaline battery will not be recharged. The internal charging circuit is designed to prevent damage to alkaline batteries and the charging circuit when alkaline batteries are installed inside the instrument. If you try to charge an alkaline batteries installed in the instrument, the instrument's display will say, "Alkaline Battery," indicating that it will not charge the alkaline batteries.

Note: When replacing alkaline batteries, dispose of old ones properly.

6 Charging A Lithium Ion Battery

Always fully charge the battery before using the instrument. The instrument's Li-ion battery is charged by attaching the instrument to the Travel Charger (or by placing the instrument in the optional Charger Stand). Contacts on the bottom of the instrument meet the Travel Charger's (or Charger Stand's) contacts, transferring power without other connections.

Note: Before connecting the Travel Charger to the instrument, visually inspect the contacts to make sure they are clean. If they are not, wipe them with a soft cloth. Do not use solvents or cleaners.

Follow this procedure to charge the instrument:

1. Plug the AC/DC adapter's barrel connector into the instrument's Charger Stand or Travel Charger.



2. Plug the AC/DC adapter into the wall outlet.
3. Connect the AC/DC adapter to the Travel Charger (or Charger Stand).
3. Place the instrument into the Travel Charger or Charger Stand. The LED in the Travel Charger (or Charger Stand) should glow.

The instrument begins charging automatically. (If the optional Charger Stand is used, the "Primary" LED blinks green to indicate charging.) During charging, the diagonal lines in the battery icon on the instrument's display are animated and you see the message "Charging..."



When the instrument's battery is fully charged, the battery icon is no longer animated and shows a full battery. The message "Fully charged!" is shown. (If the Charger Stand or Travel Charger is used, its LED glows continuously green.)



MiniRAE Lite User's Guide

Note: If you see the “Battery Charging Error” icon (a battery outline with an exclamation mark inside), check that the instrument or rechargeable battery has been properly set into the Travel Charger (or Charger Stand). If you still receive the message, check the Troubleshooting section of this guide.

Note: If the instrument or battery has been charging for more than 10 hours and you see the “Battery Charging Error” icon and a message that says, “Charging Too Long,” this indicates that the battery is not reaching a full charge. Try changing the battery and make sure the contacts on the instrument are meeting the Travel Charger’s (or Charger Stand’s) contacts. If the message is still shown, consult your distributor or RAE Systems Technical Services.

7 Charging A Spare Rechargeable Battery (Optional Charger Stand Only)

A rechargeable Li-ion battery can be charged when it is not inside the monitor. The Charger Stand is designed to accommodate both types of charging. Contacts on the bottom of the battery meet the contacts on the Charger Stand, transferring power without other connections, and a spring-loaded capture holds the battery in place during charging.

1. Plug the AC/DC adapter into the Charger Stand.
2. Place the battery into the Charger Stand, with the gold-plated contacts on top of the six matching charging pins.
3. Plug the AC/DC adapter into the wall outlet.

The battery begins charging automatically. During charging, the Secondary LED in the Charger Stand blinks green. When charging is complete, it glows steady green.

MiniRAE Lite User's Guide

Release the battery from the Charger Stand by pulling it back toward the rear of the Charger Stand and tilting it out of its slot.

Note: If you need to replace the Li-ion battery pack, replacements are available from RAE Systems. The part number is 059-3051-000.

WARNING!

To reduce the risk of ignition of hazardous atmospheres, recharge and replace batteries only in areas known to be non-hazardous. Remove and replace batteries only in areas known to be non-hazardous.

Low Voltage Warning

When the battery's charge falls below a preset voltage, the instrument warns you by beeping once and flashing once every minute, and the "empty battery" icon blinks on and off once per second. You should turn off the instrument within 10 minutes and either recharge the battery by placing the instrument in its Travel Charger or Charger Stand, or replace the battery with a fresh one with a full charge.



Clock Battery

An internal clock battery is mounted on one of the instrument's printed circuit boards. This long-life battery keeps settings in memory from being lost whenever the Li-ion battery or alkaline batteries are removed. This backup battery should last approximately five years, and must be replaced by an authorized RAE Systems service technician. It is not user-replaceable.

8 User Interface

The instrument's user interface consists of the display, LEDs, an alarm transducer, and four keys. The keys are:

- Y/+
- MODE
- N/-
- Flashlight on/off

The LCD display provides visual feedback that includes the reading, time, battery condition, and other functions.

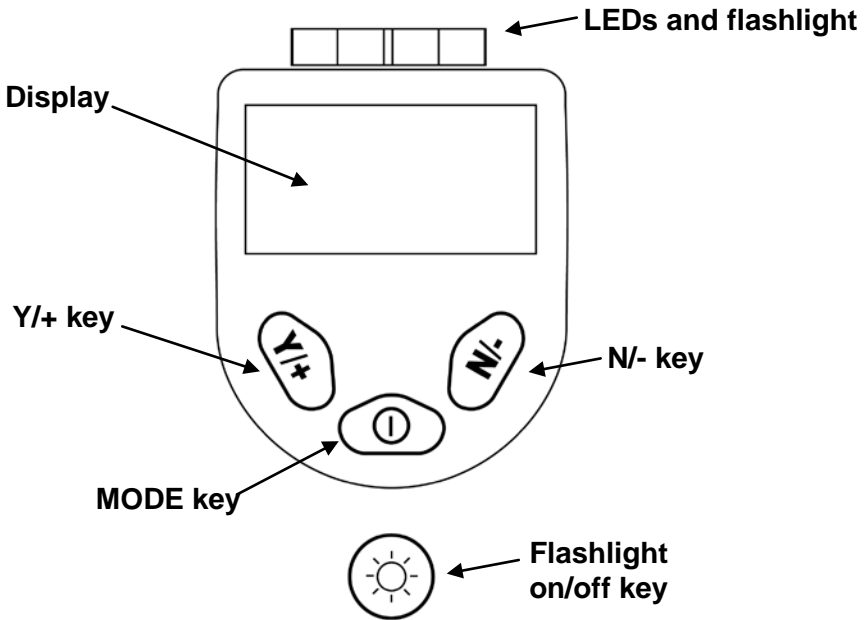

In addition to their labeled functions, the keys labeled Y/+, MODE, and N/- act as “soft keys” that control different parameters and make different selections within the instrument's menus. From menu to

MiniRAE Lite User's Guide

menu, each key controls a different parameter or makes a different selection.

Three panes along the bottom of the display are “mapped” to the keys. These change as menus change, but at all times the left pane corresponds to the [Y/+] key, the center pane corresponds to the [MODE] key, and the right pane corresponds to the [N/-] key. Here are three examples of different menus with the relationships of the keys clearly shown:

RELATIONSHIP OF BUTTONS TO CONTROL FUNCTIONS

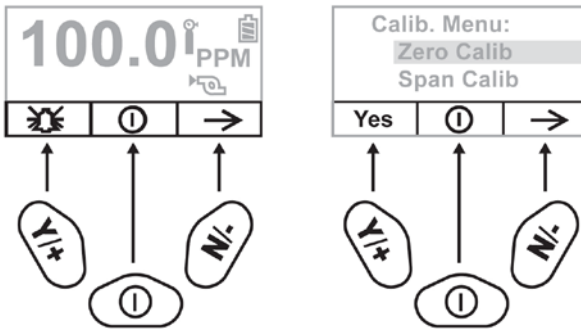

9 Display

The display shows the following information:

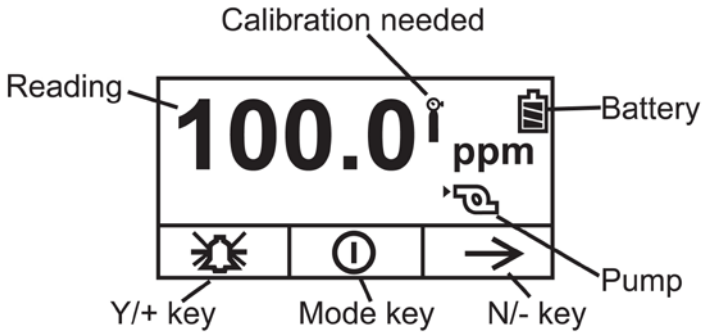

Reading	Concentration of gas as measured by the instrument
Calibration needed	Indicates that calibration should be performed
Battery	Indicates battery level in 3 bars
Pump	Indicates that pump is working
Y/+	Y/+ key's function for this screen
MODE	MODE key's function for this screen
N/-	N/- key's function for this screen

10 Operating The Instrument

The instrument is designed as a broadband VOC gas monitor for work in non-hazardous environments. It gives real-time measurements and activates alarm signals whenever the exposure exceeds preset limits. Prior to factory shipment, the instrument is preset with default alarm limits and the sensor is pre-calibrated with standard calibration gas. However, you should test the instrument and verify the calibration before the first use. After the instrument is fully charged and calibrated, it is ready for immediate operation.

11 Turning The Instrument On

1. With the instrument turned off, press and hold [MODE].
2. When the display turns on, release the [MODE] key.



The RAE Systems logo should appear first. (If the logo does not appear, there is likely a problem and you should contact your distributor or RAE Systems Technical Support.) The instrument is now operating and performs self tests. If any tests (including sensor and memory tests fail), refer to the Troubleshooting section of this guide.

Once the startup procedure is complete, the instrument shows a numerical reading screen with icons. This indicates that the instrument is fully functional and ready to use.

12 Turning The Instrument Off

1. Press and hold the Mode key for 3 seconds. A 5-second countdown to shutoff begins.
2. Once the countdown stops, the instrument is off. Release the Mode key.
3. When you see “Unit off...” release your finger from the [MODE] key. The instrument is now off.

Note: You must hold your finger on the key for the entire shutoff process. If you remove your finger from the key during the countdown, the shutoff operation is canceled and the instrument continues normal operation.

13 Operating The Built-In Flashlight

The instrument has a built-in flashlight that helps you point the probe in dark places. Press the flashlight key to turn it on. Press it again to turn it off.

Note: Using the flashlight for extended periods shortens the battery's operating time before it needs recharging.

14 Pump Status

IMPORTANT!

During operation, make sure the probe inlet and the gas outlet are free of obstructions. Obstructions can cause premature wear on the pump, false readings, or pump stalling. During normal operation, the pump icon alternately shows inflow and outflow as shown here:



MiniRAE Lite User's Guide

During duty cycling (PID lamp cleaning), the display shows these icons in alternation:

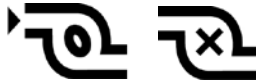

If there is a pump failure or obstruction that disrupts the pump, you will see this icon blinking on and off:



If you see this blinking icon, consult the Troubleshooting section of this guide.

15 Calibration Status

The instrument displays this icon if it requires calibration:



Calibration is required (and indicated by this icon) if:

- The sensor has been replaced.
- It has been 30 days or more since the instrument was last calibrated.
- If you have changed the calibration gas type without recalibrating the instrument.

16 Basic Operation

The instrument is programmed to give you the most commonly needed information quickly.

Pressing [N/-] steps you from one screen to the next, and eventually return to the main display. If you do not press a key within 60 seconds after entering a display, the instrument reverts to its main display.

Note: While viewing any of these screens, you can shut off your instrument by pressing [MODE].

After the instrument is turned on, it runs through the start-up menu. Then the message “Please apply zero gas...” is displayed.

At this point, you can perform a zero air (fresh air) calibration. If the ambient air is clean, you can use that. Otherwise, use a cylinder of zero air. Refer to Zero Calibration on page 31 for a more detailed description of zero calibration.

Start zero calibration by pressing Start. You see the message “Zeroing...” followed by a 30-second countdown.

Note: You can press [MODE] to quit, bypassing the zero air calibration.

When zero calibration is complete, you see the message:

Zeroing is done!

Reading = 0.0 ppm

The instrument is now sampling and collecting data.

Note: At the Average & Peak, Date & Time & Temperature, and PC Communications screens, the instrument automatically goes to the main display after 60 seconds if you do not push a key to make a selection.

17 Alarm Signals

During each measurement period, the gas concentration is compared with the programmed alarm limits (gas concentration alarm limit settings). If the concentration exceeds any of the preset limits, the loud buzzer and red flashing LED are activated immediately to warn you of the alarm condition.

In addition, the instrument alarms if one of the following conditions occurs: battery voltage falls below a preset voltage level, failure of the UV lamp, or pump stall.

Alarm Signal Summary

Message	Condition	Alarm Signal
HIGH	Gas exceeds "High Alarm" limit	3 beeps/flashes per second
OVR	Gas exceeds measurement range	3 beeps/flashes per second
MAX	Gas exceeds electronics' maximum range	3 beeps/flashes per second
LOW	Gas exceeds "Low Alarm" limit	2 beeps/flashes per second
Pump icon flashes	Pump failure	3 beeps/flashes per second
Lamp	PID lamp failure	3 beeps/flashes per second plus "Lamp" message on display
Battery icon flashes	Low battery	1 flash, 1 beep per minute plus battery icon flashes on display
CAL	Calibration failed, or needs calibration	1 beep/flash per second
NEG	Gas reading measures less than number stored in calibration	1 beep/flash per second

18 Preset Alarm Limits & Calibration

The instrument is factory calibrated with standard calibration gas, and is programmed with default alarm limits.

Cal Gas (Isobutylene)	Cal Span	Unit	Low	High
MiniRAE Lite	100	ppm	50	100

19 Testing The Alarm

You can test the alarm whenever the main (Reading) display is shown. Press [Y/+], and the audible and visible alarms are tested.

20 Integrated Sampling Pump

The instrument includes an integrated sampling pump. This diaphragm-type pump that provides a 450 to 550 cc per minute flow rate. Connecting a Teflon or metal tubing with 1/8" inside diameter to the gas inlet port of the instrument, this pump can pull in air samples from 100' (30 m) vertically or horizontally.

Note: In Search Mode, the pump turns on when a sample measurement is started, and turns off when the sample is manually stopped.

If liquid or other objects are pulled into the inlet port filter, the instrument detects the obstruction and immediately shuts down the pump. The alarm is activated and a flashing pump icon is displayed.

You should acknowledge the pump shutoff condition by clearing the obstruction and pressing the [Y/+] key while in the main reading display to restart the pump.

21 Backlight

The LCD display is equipped with an LED backlight to assist in reading the display under poor lighting conditions.

22 Standard Accessories

The following accessories are included with the instrument:

- 10.6 eV lamp
- Flex-I-Probe
- External filter
- Green rubber boot
- Alkaline battery adapter
- Lamp cleaning kit
- Tool Kit
- Lithium-Ion (Li-Ion) battery, if specified
- Travel Charger, if specified
- Universal wall adapter, if specified
- Operation & Maintenance manual
- Soft leather carrying case

23 Standard Kit & Accessories

Alkaline Battery Adapter

An alkaline battery adapter is supplied with each instrument. The adapter (part number 059-3052-000) accepts four AA alkaline batteries (use only Duracell MN1500 or Energizer E91) and provides approximately 12 hours of operation. (An optional rechargeable lithium-ion battery pack is also available.)

To insert batteries into the adapter:

1. Remove the three Philips-head screws to open the compartment in the adapter.

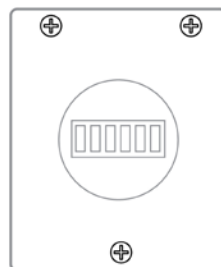

MiniRAE Lite User's Guide

2. Insert four fresh AA batteries as indicated by the polarity (+/-) markings.
3. Replace the cover. Replace the three screws.

To install the adapter in the instrument:

1. Remove the Li-ion battery pack from the instrument by sliding the tab and tilting out the battery.
2. Replace it with the alkaline battery adapter
3. Slide the tab back into place to secure the battery adapter.

IMPORTANT!

Alkaline batteries cannot be recharged. The instrument's internal circuit detects alkaline batteries and will not allow recharging. If you place the instrument in its Travel Charger or Charger Stand, the alkaline battery will not be recharged. The internal charging circuit is designed to prevent damage to alkaline batteries and the charging circuit when alkaline batteries are installed inside the instrument. If you try to charge an alkaline batteries installed in the instrument, the instrument's display will say, "Alkaline Battery," indicating that it will not charge the alkaline batteries.

Note: When replacing alkaline batteries, dispose of old ones properly.

24 External Filter

The external filter is made of PTFE (Teflon[®]) membrane with a 0.45 micron pore size to prevent dust or other particles from being sucked into the sensor manifold, which would cause extensive damage to the instrument. It prolongs the operating life of the sensor. To install the external filter, simply connect it to the instrument's inlet tube.

25 Optional Accessories

Calibration Adapter

The calibration adapter for the instrument is a simple 6-inch Tygon tubing with a metal adapter on one end. During calibration, simply insert the metal adapter into the regular gas inlet probe of the instrument and the tubing to the gas regulator on the gas bottle.

Calibration Regulator

The Calibration Regulator is used in the calibration process. It regulates the gas flow rate from the Span gas cylinder into the gas inlet of the instrument during calibration process. The maximum flow rate allowed by the flow controller is about 0.5L/min (500 cc per min.). Alternatively, a demand-flow regulator or a Tedlar gas bag may be used to match the pump flow precisely.

Organic Vapor Zeroing Kit

The Organic Vapor Zeroing Kit is used for filtering organic air contaminants that may affect the zero calibration reading. To use the Organic Vapor Zeroing Kit, simply connect the filter to the inlet port of the instrument.

Travel Charger

WARNING

A battery charging circuit is built into the mini charger. It only needs a regular AC to 12 VDC adapter (wall-mount transformer, part number 500-0114-000) to charge the instrument.

To charge the battery:

1. Power off the instrument.
2. Connect the AC adapter to the DC jack on the instrument's Travel Charger or Charger Stand. If the instrument is off, it automatically turns on.
3. While charging, the display message shows "Charging."

MiniRAE Lite User's Guide

4. When the battery is fully charged, the message "Fully charged" appears on the display.

A completely discharged instrument can be charged to full capacity within 8 hours. Batteries drain slowly even if an instrument is off. Therefore, if the instrument has been in storage or has not been charged for several days or longer, check the charge before using it. The factory-supplied battery is designed to last for 16 hours of normal operation (no alarm), for a new battery under the optimum circumstances. As the battery becomes older or is subject to adverse conditions (such as cold ambient temperature), its capacity will be significantly reduced.

26 Standard Two-Point Calibration (Zero & Span)

The following diagram shows the instrument's calibrations.

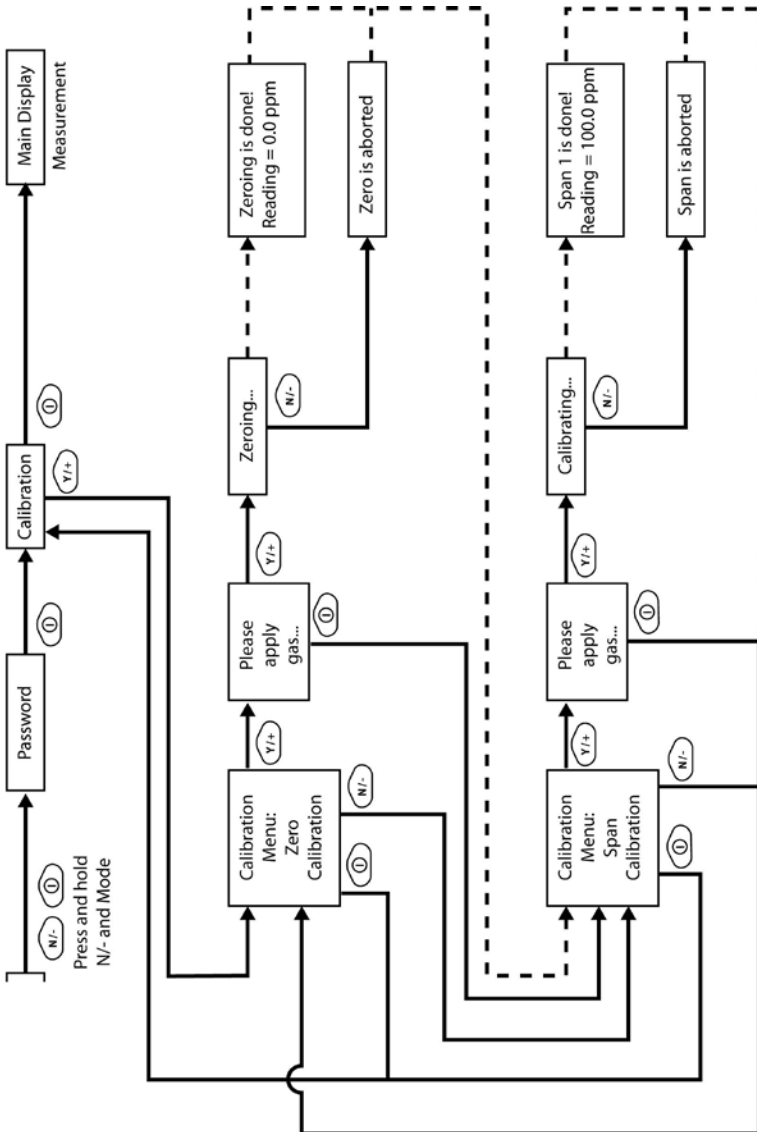

Note: Dashed line indicates automatic progression.

Entering Calibration

1. Press and hold [MODE] and [N/-] until you see the Password screen.

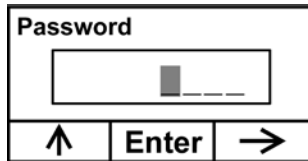

2. You do not need a password to perform calibrations. Instead of inputting a password, enter calibration by pressing [MODE].

Note: If you inadvertently press [Y/+] and change any of the numbers, simply press [MODE] and you will be directed to the calibration menu.

The Calibration screen is now visible with Zero Calibration highlighted.

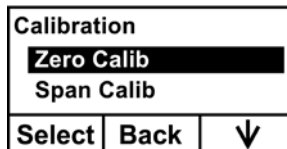

These are your options:

- Press [Y/+] to select the highlighted calibration (Zero Calib or Span Calib).
- Press [MODE] to exit calibration and return to the main display and resume measurement.
- Press [N/-] to toggle the highlighted calibration type.

Zero (Fresh Air) Calibration

This procedure determines the zero point of the sensor calibration curve. To perform a fresh air calibration, use the calibration adapter to connect the instrument to a “fresh” air source such as from a cylinder or Tedlar bag (optional accessory). The “fresh” air is clean, dry air without organic impurities and an oxygen value of 20.9%. If such an air cylinder is not available, any clean ambient air without detectable contaminants or a charcoal filter can be used.

At the Zero Calibration menu, you can proceed to perform a Zero calibration or bypass Zero calibration and perform a Span calibration. You may also go back to the initial Calibration menu if you want to exit calibration.

- Press [Y/+] to start calibration.
- Press [MODE] to quit and return to the main calibration display.

If you have pressed [Y/+] to enter Zero calibration, then you will see this message:

Please apply zero gas...		
Start	Quit	

1. Turn on your Zero calibration gas.
2. Press [Y/+] to start calibration.

Note: At this point, you may press [MODE] if you decide that you do not want to initiate calibration. This will take you directly to the Calibration menu, highlighted for Span calibration.

MiniRAE Lite User's Guide

3. Zero calibration starts a 30-second countdown and displays this message:

Zeroing...

During the zeroing process, the instrument performs the Zero calibration automatically and does not require any action on your part.

Note: To abort the zeroing process at any time and proceed to Span calibration, press [N/-] at any time while zeroing is being performed. You will see a confirmation message that says "Zero aborted!" and then the Span calibration menu appears.

When Zero calibration is complete, you see this message:

Zeroing is done!
Reading = 0.0 ppm

The instrument will then show the Calibration menu on its display, with Span Calib highlighted.

MiniRAE Lite User's Guide

Span Calibration

This procedure determines the second point of the sensor calibration curve for the sensor. A cylinder of standard reference gas (span gas) fitted with a 500 cc/min. flow-limiting regulator or a flow-matching regulator is the simplest way to perform this procedure. Choose the 500 cc/min. regulator only if the flow rate matches or slightly exceeds the flow rate of the instrument pump. Alternatively, the span gas can first be filled into a Tedlar bag or delivered through a demand-flow regulator. Connect the calibration adapter to the inlet port of the instrument, and connect the tubing to the regulator or Tedlar bag.

Another alternative is to use a regulator with >500 cc/min flow but allow the excess flow to escape through a T or an open tube. In the latter method, the span gas flows out through an open tube slightly wider than the probe, and the probe is inserted into the calibration tube.

At the Span Calibration menu, you perform a Span calibration. You may also go back to the Zero calibration menu or to the initial Calibration menu if you want to exit calibration.

- Press [Y/+] to enter Span calibration.
- Press [N/-] to skip Span calibration and return to Zero calibration.
- Press [MODE] to exit Span calibration and return to the top calibration menu.

If you have pressed [Y/+] to enter Span calibration, then you will see the name of your Span gas (the default is isobutylene) and the span value in parts per million (ppm). You will also see this message that prompts you:

C. Gas = Isobutene		
Span = 100 ppm		
Please apply gas 1...		
Start	Quit	

MiniRAE Lite User's Guide

1. Turn on your span calibration gas.
2. Press [Y/+] to initiate calibration.

Note: You may press [MODE] if you decide that you do not want to initiate calibration. This will abort the span calibration and take you directly to the Calibration menu for Zero calibration.

3. Span calibration starts and displays this message:

Calibrating...

During the Span calibration process, there is a 30-second countdown and the instrument performs the Span calibration automatically. It requires no actions on your part.

Note: If you want to abort the Span calibration process, press [N/-] at any time during the process. You will see a confirmation message that says "Span is aborted!" and then the Zero calibration menu appears. You can then proceed to perform a Zero calibration, perform a Span calibration, or exit to the topmost Calibration menu.

When Span calibration is complete, you see a message similar to this (the value is an example only):

Span 1 is done!
Reading = 100.0 ppm

The instrument then exits Span calibration and shows the Zero calibration menu on its display.

Note: The reading should be very close to the span gas value.

Exiting Two-Point Calibration

When you are done performing calibrations, press [MODE], which corresponds with “Back” on the display. You will see the following message:

Updating settings...

The instrument updates its settings and then returns to the main display. It begins or resumes monitoring.

27 Programming Mode

You must provide a 4-digit password to enter Programming Mode.

Entering Programming Mode

1. Press and hold [MODE] and [N/-] until you see the Password screen.

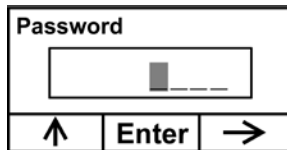

2. Input the 4-digit password:

- Increase the number from 0 through 9 by pressing [Y/+].
- Step from digit to digit using [N/-].
- Press [MODE] when you are done.

If you make a mistake, you can cycle through the digits by pressing [N/-] and then using [Y/+] to change the number in each position.

MiniRAE Lite User's Guide

Note: The default password is 0000.

When you have successfully entered Programming Mode, you see this screen:

Calibration

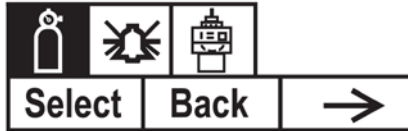

Note: The password can only be changed by connecting the instrument to a PC running ProRAE Studio software. Follow the instructions in ProRAE Studio to change it. The Calibration label is shown and its icon is highlighted, but you can press [N/-] to step from one programming menu to the next, with the name of the menu shown at the top of the display and the corresponding icon highlighted. As you repeatedly press [N/-], the selection moves from left to right, and you see these screens:

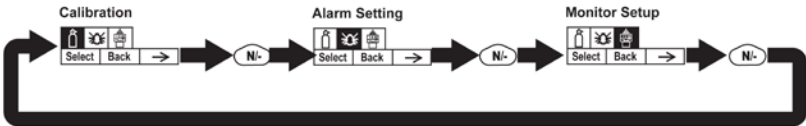



Note: When you reach Monitor Setup and press [N/-], the menu cycles back to Calibration.

28 Programming Mode Menus

The Programming Mode allows anyone with the password to change the instrument's settings, calibrate the instrument, enter user information, etc. Programming Mode has three menus. Each menu includes several sub-menus to perform additional programming functions.

This table shows the menus and sub-menus:

		
Calibration	Alarm Setting	Monitor Setup
Zero Calibration	High Alarm	Date
Span Calibration	Low Alarm	Time
	Alarm Type	Language
	Buzzer & Light	Power On Zero
		LCD Contrast

Once you enter Programming Mode, the LCD displays the first menu, Calibration. Each subsequent menu is accessed by pressing [N/-] repeatedly until the desired menu is displayed. To enter a sub-menu of a menu, press [Y/+].

Exiting Programming Mode

To exit Programming Mode and return to normal operation, press [MODE] once at any of the programming menu displays. You will see “Updating Settings...” as changes are registered and the mode changes.

Navigating Programming Mode Menus

Navigating through the Programming Mode menus is easy and consistent, using a single interface format of “Select,” “Back” and “Next” at the top level. The three control buttons correspond to these choices as shown:

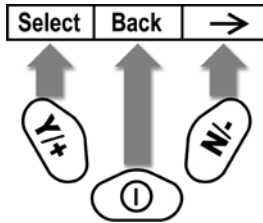

Note: Pressing [MODE] in the Programming Mode’s top level causes the instrument to exit Programming Mode and return to monitoring.

The three keys perform the following functions in Programming Mode:

29 Key Function in Programming Mode

[MODE]:	Exit menu when pressed momentarily or exit data entry mode
[Y/+]:	Increase alphanumerical value for data entry or confirm (yes) for a question
[N/-]:	Provides a “no” response to a question

Calibration

Two types of calibration are available: Zero (fresh air) and Span.

Calibration

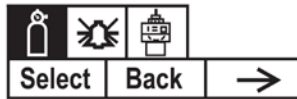

Select Zero or Span Calibration by pressing [N/+]. Once your choice is highlighted, press [Y/+].

Zero Calibration

The procedure for performing a zero calibration is covered on page 29.

Span Calibration

The procedure for performing a basic span calibration is covered on page 29.

Alarm Setting

During each measurement period, the gas concentration is compared with the programmed alarm limits (gas concentration alarm limit settings: Low and High). If the concentration exceeds any of the preset limits, the loud buzzer and red flashing LED are activated immediately to warn of the alarm condition.

An alarm signal summary is shown on page 23.

In this menu, you can change the High and Low alarm limits. Press [Y/+] to enter the Alarm Setting menu. **Note:** All settings are shown in ppb (parts per billion), or $\mu\text{g}/\text{m}^3$ (micrograms per cubic meter), depending on your setting.

Alarm Setting



1. Scroll through the Alarm Limit sub-menu using the [N/-] key until the display shows the desired limit to be changed (High Alarm and Low Alarm).
 2. Press [Y/+] to select one of the alarm types. The display shows a flashing cursor on the left-most digit of the previously stored alarm limit.
 3. Press [Y/+] to increase each digit's value.
 4. Press [N/-] to advance to the next digit.
 5. Again, use [Y/+] to increase the number.
- Repeat this process until all numbers are entered.

Press [MODE] when you are done.

- Press [Y/+] to save the changes.
- Press [N/-] to undo the changes and revert to the previous settings.

MiniRAE Lite User's Guide

When all alarm types have been changed or bypassed, press [MODE] to exit to the Programming Menu.

High Alarm

You can change the High Alarm limit value. The value is typically set by the instrument to match the value for the current calibration gas. It is expressed in parts per billion (ppb). **Note:** The default value depends on the measurement gas.

To change the High Alarm value:

1. Press [Y/+] to increase each digit's value.
2. Press [N/-] to advance to the next digit.
3. Again, use [Y/+] to increase the number.

Repeat this process until all numbers are entered.

When you have completed your selections, press [MODE]. You will see two choices: Save and Undo. You have the opportunity to register the new settings or to change your mind and revert to your previous settings.

Press [Y/+] to save the changes.

Press [N/-] to undo the changes and revert to the previous settings.

Low Alarm

You can change the Low Alarm limit value. The value is typically set by the instrument to match the value for the current calibration gas. It is expressed in parts per billion (ppb). **Note:** The default value depends on the measurement gas.

To change the Low Alarm value:

1. Press [Y/+] to increase each digit's value.
2. Press [N/-] to advance to the next digit.
3. Again, use [Y/+] to increase the number.

MiniRAE Lite User's Guide

Repeat this process until all numbers are entered.

When you have completed your selections, press [MODE]. You will see two choices: Save and Undo. You have the opportunity to register the new settings or to change your mind and revert to your previous settings.

- Press [Y/+] to save the changes.
- Press [N/-] to undo the changes and revert to the previous settings.

Alarm Type

There are two selectable alarm types:

Latched

When the alarm is triggered, you can manually stop the alarm.

The latched setting only controls alarms for High Alarm and Low Alarm.

Note: To clear an alarm when the instrument is set to “Latched,” press [Y/+] when the main (Reading) display is shown.

Automatic Reset

When the alarm condition is no longer present, the alarm stops and resets itself.

1. Press [N/-] to step from one alarm type to the other.
2. Press [Y/+] to select an alarm type.

When you have completed your selections, press [MODE].

You will see two choices: Save and Undo. You have the opportunity to register the new settings or to change your mind and revert to your previous settings.

- Press [Y/+] to save the changes.

MiniRAE Lite User's Guide

- Press [N/-] to undo the changes and revert to the previous settings.

MiniRAE Lite User's Guide

Buzzer & Light

The buzzer and light alarms can be programmed to be on or off individually or in combination. Your choices are:

- Both on
 - Light only
 - Buzzer only
 - Both off
4. Press [N/-] to step from one option to the next.
 5. Press [Y/+] to make your selection (the dark circle in the “radio button” indicates your selection).
 6. When you have completed your selections, press [MODE].

You will see two choices: Save and Undo. You have the opportunity to register the new settings or to change your mind and revert to your previous settings.

- Press [Y/+] to save the changes.
- Press [N/-] to undo the changes and revert to the previous settings.

Date

The Date is expressed as Month/Day/Year, with two digits for each.

Press [Y/+] and the display shows the current date. Note that the left-most digit flashes to indicate it is selected.

Press [Y/+] to step through all 10 numerals (0 to 9).

Press [N/-] to advance to the next digit. The next digit to the right flashes.

Repeat this process until all six digits of the new date are entered.

Press [MODE] to exit.

Press [Y/+] to save the new date.

MiniRAE Lite User's Guide

Press [N/-] to undo the change and move to the next sub-menu.

Time

The Time is expressed as Hours/Minutes/Seconds, with two digits for each. The time is in 24-hour (military) format.

- Press [Y/+] and the display shows the current time. Note that the left-most digit flashes to indicate it is selected.
- Press [Y/+] to step through all 10 numerals (0 to 9).
- Press [N/-] to advance to the next digit. The next digit to the right flashes.

Repeat this process until all six digits of the new time are entered.

Press [MODE] to exit.

- Press [Y/+] to save the new date.
- Press [N/-] to undo the change and move to the next sub-menu.

Language

English is the default language, but other languages can be selected for the instrument.

1. Press [N/-] to step from one option to the next.
2. Press [Y/+] to make your selection (the dark circle in the “radio button” indicates “on”).
3. When you have completed your selection, press [MODE].
 - Press [Y/+] to save your new language choice.
 - Press [N/-] to undo it and return to the previous language selection.

MiniRAE Lite User's Guide

Power On Zero

When Power On Zero is on, the instrument performs a zero calibration when it is turned on.

1. Press [N/-] to step from one option to the next.
2. Press [Y/+] to make your selection (the dark circle in the “radio button” indicates your selection).
3. When you have completed your selection, press [MODE].
 - Press [Y/+] to save the change.
 - Press [N/-] to discard the change and move to the next sub-menu.

LCD Contrast

The display's contrast can be increased or decreased from its default setting. You may not need to ever change the default setting, but sometimes you can optimize the display to suit extreme temperature and ambient brightness/darkness conditions.

- The minimum value is 20.
 - The maximum value is 60.
1. Press [Y/+] to increase the value or [N/-] to decrease the value.
 2. Press [MODE] to save your selection.
 - Press [Y/+] to save your new contrast value.
 - Press [N/-] to undo it and return to the previous value.

Diagnostic Mode

IMPORTANT! Diagnostic Mode is designed for servicing and manufacturing, and therefore is not intended for everyday use, even by advanced users. It provides raw data from sensors and about settings, but only allows adjustment of pump stall parameters, which should only be changed by qualified personnel.

Note: If the instrument is turned on in Diagnostic Mode and you switch to User Mode, data remains in raw count form. To change to standard readings, you must restart the instrument.

Entering Diagnostic Mode

Note: To enter Diagnostic Mode, you must begin with the instrument turned off.

Press and hold [Y/+] and [MODE] until the instrument starts.

The instrument goes through a brief startup, and then displays raw data for the PID sensor. These numbers are raw sensor readings without calibration. The instrument is now in Diagnostic Mode.

Note: In Diagnostic Mode, the pump and lamp are normally on.

You can enter Programming Mode and calibrate the instrument as usual by pressing both [MODE] and [N/-] for three seconds.

You can enter Monitoring Mode by pressing [MODE] and [Y/+] together for three seconds.

Once the instrument is started up in Diagnostic Mode, you can switch between Diagnostic Mode and Monitoring Mode by pressing and holding [MODE] and [Y/+] simultaneously for two seconds.

In Diagnostic mode, you can step through parameter screens by pressing [MODE].

MiniRAE Lite User's Guide

Adjusting The Pump Stall Threshold

If the gas inlet is blocked but the pump does not shut down, or the pump shuts down too easily with a slight blockage, the pump stall threshold value may be set too high or too low.

Use the following steps to adjust the pump stall threshold:

Pump High

In Diagnostic Mode, press the [MODE] key until "Pump High" is displayed. The pump shows the maximum, minimum, and stall values for the pump at its high speed.

Block the gas inlet and watch the pump current reading (labeled "I") increase. Write down the blocked reading. If the pump current reading does not increase significantly (for example, more than 10 counts), then there may be a leak in the gas inlet or the pump is weak or defective.

Use the [Y/+] or [N/-] key to increase or decrease the stall value until it is the average of the maximum block count and the maximum idle count.

Press the [MODE] key to exit this display.

Pump Low

In Diagnostic Mode, press the [MODE] key until "Pump Low" is displayed. The pump shows the maximum, minimum, and stall values for the pump at its low speed.

Block the gas inlet and watch the pump current reading (labeled "I") increase. Write down the blocked reading. If the pump current reading does not increase significantly (for example, more than 10 counts), then there may be a leak in the gas inlet or the pump is weak or defective.

MiniRAE Lite User's Guide

Use the [Y/+] or [N/-] key to increase or decrease the stall value until it is the average of the maximum block count and the maximum idle count.

Press the [MODE] key to exit this display.

Exiting Diagnostic Mode

You can exit Diagnostic Mode and go directly to Programming Mode or Monitor Mode as outlined above, or you can exit Diagnostic Mode completely.

To exit Diagnostic Mode so that it cannot be re-entered without a restart:

Shut down the instrument. When it is off, restart it by holding the [MODE] key. Diagnostic Mode cannot be entered until the instrument is restarted as outlined in “Entering Diagnostic Mode.”

30 Updating Firmware From A Computer

You can connect the Travel Charger or optional Charger Stand to a PC and transfer updated firmware to the instrument (should this ever be necessary).

Uploading Firmware To The instrument From A PC

Uploading new firmware to your instrument requires connecting the instrument and PC via the Travel Charger or optional Charger Stand. It also requires RAE Programmer 7000 software, which is available by downloading ProRAE Studio version 1.12 from the RAE Systems website (www.raesystems.com). Follow these steps to make the connection:

1. Connect the data cable to the PC and the charger/cradle.
2. Place the instrument into the charger/cradle. The charging LED should be illuminated.
3. Start RAE Programmer 7000 on your PC.
4. Select "Operation" and select Setup Connection.
5. Select the COM port to establish a communication link between the PC and the instrument.
6. Select Operation → Download Firmware.

Once communication is established, follow the software's instructions to upload the new firmware to your instrument.

Note: Check for the latest updates to ProRAE Studio at www.raesystems.com.

31 Maintenance

The major maintenance items of the instrument are:

- Battery pack
- Sensor module
- PID lamp
- Sampling pump
- Inlet connectors and filters

Note: Maintenance should be performed by qualified personnel only.

NOTE: The printed circuit board of the instrument is connected to the battery pack even if the power is turned off. Therefore, it is very important to disconnect the battery pack before servicing or replacing any components inside the instrument. Severe damage to the printed circuit board or battery may occur if the battery pack is not disconnected before servicing the unit.

Battery Charging & Replacement

When the display shows a flashing empty battery icon, the battery requires recharging. It is recommended to recharge the instrument upon returning from fieldwork. A fully charged battery runs a instrument for 16 hours continuously. The charging time is less than 8 hours for a fully discharged battery. The battery may be replaced in the field (in areas known to be non-hazardous), if required.

WARNING!

To reduce the risk of ignition of hazardous atmospheres, recharge battery only in area known to be non-hazardous. Remove and replace battery only in areas known to be non-hazardous.

MiniRAE Lite User's Guide

Replacing The Li-ion Battery Or Alkaline Adapter

1. Turn off the instrument.
2. Located on the rear of the instrument is a battery tab. Slide it down to unlock the battery.

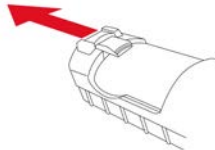

3. Remove the battery pack from the battery compartment by tilting it out.



4. Replace a fully charged spare battery pack inside the battery compartment. Make sure the battery pack is oriented properly inside the compartment.
5. Slide the capture tab back up to its locked position.

IMPORTANT!

Alkaline batteries cannot be recharged. The instrument's internal circuit detects alkaline batteries and will not allow recharging. If you place the instrument in its cradle, the alkaline battery will not be recharged. The internal charging circuit is designed to prevent damage to alkaline batteries and the charging circuit when alkaline batteries are installed inside the instrument.

Note: When replacing alkaline batteries, dispose of old ones properly.

WARNING!

To reduce the risk of ignition of hazardous atmospheres, recharge the battery only in areas known to be non-hazardous. Remove and replace the battery only in areas known to be non-hazardous.

MiniRAE Lite User's Guide

Note: The internal charging circuit is designed to prevent charging to alkaline batteries.

PID Sensor & Lamp Cleaning/Replacement

The sensor module is made of several components and is attached to the lamp-housing unit as shown below.

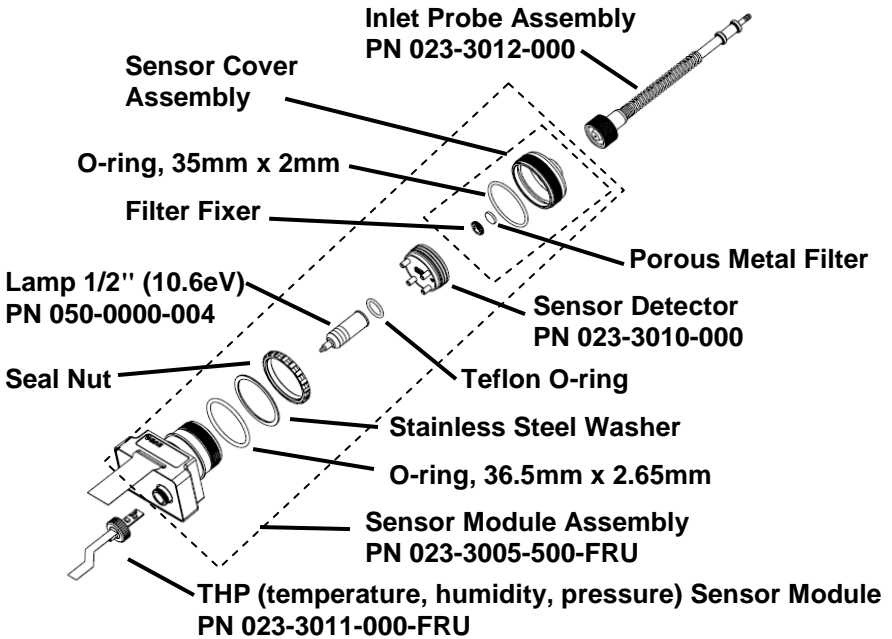

Sensor Components

Note: The cleaning procedure is not normally needed. Clean the PID sensor module, the lamp and the lamp housing only if:

1. The reading is inaccurate even after calibration.
2. The reading is very sensitive to air moisture.
3. A liquid has been sucked into the unit and damaged the unit.

Use of the external filter helps to prevent contamination of the sensor.

To access the sensor components and lamp, gently unscrew the lamp-housing cap, remove the sensor adapter with the gas inlet probe and

MiniRAE Lite User's Guide

the metal filter all together. Then hold the PID sensor and pull it straight out. A slight, gentle rocking motion helps release the sensor.

Cleaning The PID Sensor

Place the entire PID sensor module into GC grade methanol. It is highly recommended that an ultrasound bath to be used to clean the sensor for at least 15 minutes. Then dry the sensor thoroughly. Never touch the electrodes of the sensor by hand.

Also use a methanol-soaked cotton swab to wipe off the lamp housing where it contacts the sensor when the sensor is installed.

Turn over the sensor so that the pins point up and the sensor cavity is visible. Examine the sensor electrodes for any corrosion, damage, or bending out of alignment. The metal sensor electrode “fingers” should be flat and straight. If necessary, carefully bend the sensor fingers to ensure that they do not touch the Teflon portions and that they are parallel to each other. Make sure that the nuts on the sensor pins are snug but not overtight. If the sensor is corroded or otherwise damaged, it should be replaced.

Cleaning The Lamp Housing Or Changing The Lamp

If the lamp does not turn on, the instrument will display an error message to indicate replacement of the lamp may be required.

1. If the lamp is operational, clean the lamp window surface and the lamp housing by wiping it with GC grade methanol using a cotton swab using moderate pressure. After cleaning, hold the lamp up to the light at an angle to detect any remaining film. Repeat the process until the lamp window is clean. Never use water solutions to clean the lamp. Dry the lamp and the lamp housing thoroughly after cleaning.

CAUTION: Never touch the window surface with the fingers or anything else that may leave a film. Never use acetone or aqueous solutions.

MiniRAE Lite User's Guide

2. If the lamp does not turn on, remove the lamp from the lamp housing. Place the lamp O-ring onto the new lamp. Insert the new lamp, avoiding contact with the flat window surface.
3. Reinstall the PID sensor module.
4. Tighten the Lamp Housing Cap.

MiniRAE Lite User's Guide

Sampling Pump

When approaching the end of the specified lifetime of the pump, it will consume higher amount of energy and reduce its sample draw capability significantly. When this occurs, it is necessary to replace or rebuild the pump. When checking the pump flow, make sure that the inlet connector is tight and the inlet tubing is in good condition. Connect a flow meter to the gas inlet probe. The flow rate should be above 450 cc/min when there is no air leakage.

If the pump is not working properly, refer the instrument to qualified service personnel for further testing and, if necessary, pump repair or replacement.

Cleaning The Instrument

Occasional cleaning with a soft cloth is recommended. Do not use detergents or chemicals.

Visually inspect the contacts at the base of the instrument, on the battery, and on the Travel Charger or Charger Stand to make sure they are clean. If they are not, wipe them with a soft, dry cloth. Never use solvents or cleaners.

Ordering Replacement Parts

If you need replacement parts, contact your local RAE Systems distributor. A list is available online:

<http://www.raesystems.com>

In the U.S., you can order sensors, replacement batteries, and other accessories online at:

<http://istore.raesystems.com/>

Special Servicing Note

If the instrument needs to be serviced, contact either:

The RAE Systems distributor from whom the instrument was purchased; they will return the instrument on your behalf.

or

The RAE Systems Technical Service Department. Before returning the instrument for service or repair, obtain a Returned Material Authorization (RMA) number for proper tracking of your equipment.

This number needs to be on all documentation and posted on the outside of the box in which the instrument is returned for service or upgrade. Packages without RMA Numbers will be refused at the factory.

32 Troubleshooting

Problem	Possible Reasons & Solutions
Cannot turn on power after charging the battery	<p>Reasons: Discharged battery. Defective battery.</p> <p>Solutions: Charge or replace battery.</p>
Lost password	<p>Solutions: Call Technical Support at +1 408-752-0723 or toll-free at +1 888-723-4800</p>
Reading abnormally High	<p>Reasons: Dirty filter. Dirty sensor module. Excessive moisture and water condensation. Incorrect calibration.</p> <p>Solutions: Replace filter. Blow-dry the sensor module Calibrate the unit.</p>
Reading abnormally Low	<p>Reasons: Dirty filter. Dirty sensor module. Weak or dirty lamp. Incorrect calibration.</p> <p>Solutions: Replace filter. Remove Calibration Adapter. Calibrate the unit. Check for air leakage.</p>
Buzzer Inoperative	<p>Reasons: Bad buzzer.</p> <p>Solutions: Check that buzzer is not turned off. Call authorized service center.</p>

MiniRAE Lite User's Guide

Inlet flow too low	Reasons: Pump diaphragm damaged or has debris. Flow path leaks. Solutions: Check flow path for leaks; sensor module O-ring, tube connectors, Teflon tube compression fitting. Call Technical Support at +1 408-752-0723 or toll-free at +1 888-723-4800.
“Lamp” message during operation	Reasons: Lamp drive circuit. Weak or defective PID lamp, defective. Solutions: Turn the unit off and back on. Replace UV lamp

33 Technical Support

To contact RAE Systems Technical Support Team:

Monday through Friday, 7:00AM to 5:00PM Pacific (US) Time

Phone (toll-free): +1 888-723-4800

Phone: +1 408-952-8461

Email: tech@raesystems.com

Life-critical after-hours support is available:

+1 408-952-8200 select option 9

34 RAE Systems Contacts

RAE Systems

World Headquarters

3775 N. First St.

San Jose, CA 95134-1708 USA

Phone: +1 408.952.8200

Fax: +1 408.952.8480

E-mail: customerserv@raesystems.com

Web Site: www.raesystems.com

RAE Systems Technical Support

Monday through Friday, 7:00AM to 5:00PM Pacific Time

Phone: +1.408.952.8461

Email: tech@raesystems.com

Life-critical after-hours support is available:

+1.408.952.8200 select option 9

RAE Systems Europe ApS

Kirstinehøj 23 A

DK-2770 Kastrup

Denmark

Phone: +45 86 52 51 55

Fax: +45 86 52 51 77

orders@raeeurope.com

sales@raeeurope.com

service@raesystems.com

Web: www.raesystems.dk

MiniRAE Lite User's Guide

RAE Systems UK Ltd

D5 Culham Innovation Centre
Culham Science Centre
Abingdon, Oxon OX14 3DB
United Kingdom

Phone: +44 1865408368

Fax: +44 1235531119

Mobile: +44 7841362693

Email: raeuk@raeurope.com

RAE Systems France

336, rue de la fée des eaux
69390 Vernaison
France

Phone: +33 4 78 46 16 65

Fax: +33 4 78 46 25 98

Email: info-france@raeurope.com

Web: www.raesystems.fr

RAE BeNeLux BV

Rijndal 20
2904 DC Capelle a/d IJssel

Phone: +31 10 4426149

Fax: +31 10 4426148

Email: info@rae.nl

Web: www.rae.nl

RAE Systems Spain, s.l.

Av. Remolar, 31
08820 El Prat de Llobregat
Spain

Phone: +34 933 788 352

Fax: +34 933 788 353

Mobile: +34 687 491 106

Email: mdelgado@raespain.com

Web: www.raespain.com

MiniRAE Lite User's Guide

RAE Systems Middle East

Lot 7, Ground Floor, Office 19

Jebel Ali Free Zone

Dubai

United Arab Emirates

Phone: +971 4 887 5562

Fax: +971 4 887 5563

Email: mesales@raesystems.com

RAE Systems (Hong Kong) Ltd.

Room 8, 6/F, Hong Leong Plaza

33 Lok Yip Road

Fanling, N.T, Hong Kong

Phone: +852.2669.0828

Fax: +852.2669.0803

Email: hksales@raesystems.com

RAE Systems Japan

403 Plaza Ochanomizu Bldg. 2-1

Surugadai Kanda Chiyoda-Ku

Tokyo, Japan

Phone: 81-3-5283-3268

Fax: 81-3-5283-3275

Email: jpsales@raesystems.com

RAE Systems Korea

#1010, DaeMyungAnsVill First,

Sang-Dong 412-2, Wonmi-Gu, Bucheon,

Kyungki-Do, Korea

Phone: 82-32-328-7123

Fax: 82-32-328-7127

Email: krsales@raesystems.com

Controlled Part of Manual

Intrinsic Safety:

US and Canada: Class I, Division 1, Groups A,B,C,D T4

Europe: ATEX (0575 Ex II 2G Ex ia IIC/IIB T4 Gb)

KEMA 07 ATEX 0127

Complies with EN60079-0:2009, EN60079-11:2007

IECEX CSA 10.0005 Ex ia IIC/IIB T4 Gb

Complies with IEC 60079-0:2007, IEC 60079-11:2006

Temperature: -20° C to 50° C (-4° to 122° F)

Humidity: 0% to 95% relative humidity (non-condensing)

Basic Operation

1.1 Turning The Instrument On

1. With the instrument turned off, press and hold [MODE].
2. When the display turns on, release the [MODE] key.

The instrument is now operating and performs self tests. Once the self tests are complete, the display shows a graph or numerical gas reading. This indicates that the instrument is fully functional and ready to use.

1.2 Turning The Instrument Off

1. Press and hold the Mode key for 3 seconds. A 5-second countdown to shutoff begins.

MiniRAE Lite User's Guide

2. When you see “Unit off...” release your finger from the [MODE] key. The instrument is now off.

Note: You must hold your finger on the key for the entire shutoff process. If you remove your finger from the key during the countdown, the shutoff operation is canceled and the instrument continues normal operation.

Alarm Signals

During each measurement period, the gas concentration is compared with the programmed alarm limits (gas concentration alarm limit settings). If the concentration exceeds any of the preset limits, the loud buzzer and red flashing LED are activated immediately to warn you of the alarm condition.

In addition, the instrument alarms if one of the following conditions occurs: battery voltage falls below a preset voltage level, failure of the UV lamp, pump stall, or when the datalog memory is full.

1.3 Alarm Signal Summary

Message	Condition	Alarm Signal
HIGH	Gas exceeds “High Alarm” limit	3 beeps/flashes per second*
OVR	Gas exceeds measurement range	3 beeps/flashes per second*
MAX	Gas exceeds electronics' maximum range	3 beeps/flashes per second*
LOW	Gas exceeds “Low Alarm” limit	2 beeps/flashes per second*
Pump icon flashes	Pump failure	3 beeps/flashes per second
Lamp	PID lamp failure	3 beeps/flashes per second plus “Lamp” message on display
Battery icon flashes	Low battery	1 flash, 1 beep per minute plus battery icon flashes on display

MiniRAE Lite User's Guide

CAL	Calibration failed, or needs calibration	1 beep/flash per second
NEG	Gas reading measures less than number stored in calibration	1 beep/flash per second

Preset Alarm Limits & Calibration

The instrument is factory calibrated with standard calibration gas, and is programmed with default alarm limits.

Cal Gas (Isobutylene)	Cal Span	unit	Low	High	TWA	STEL
ppbRAE 3000	10	ppm	10	25	10	25
MiniRAE 3000	100	ppm	50	100	10	25
MiniRAE Lite	100	ppm	50	100	--	--
UltraRAE 3000	100	ppm	50	100	10	25

Charging The Battery

Always fully charge the battery before using the instrument. The instrument's Li-ion/NiMH battery is charged by placing the instrument in its cradle. Contacts on the bottom of the instrument meet the cradle's contacts, transferring power without other connections.

Note: Before setting the instrument into its charging cradle, visually inspect the contacts to make sure they are clean. If they are not, wipe them with a soft cloth. Do not use solvents or cleaners.

Follow this procedure to charge the instrument:

1. Plug the AC/DC adapter's barrel connector into the instrument's cradle.



2. Plug the AC/DC adapter into the wall outlet.
3. Place the instrument into the cradle, press down, and lean it back. It locks in place and the LED in the cradle glows.

Note: To release the instrument, press down and tilt the top out of the cradle and lift up.

The instrument begins charging automatically. The LED on the front of the cradle marked "Primary" blinks during charging. During charging, the diagonal lines in the battery icon on the instrument's display are animated and you see the message "Charging..."

When the instrument's battery is fully charged, the battery icon is no longer animated and shows a full battery. The message "Fully charged!" is shown and the Primary LED on the cradle glows continuously green.

MiniRAE Lite User's Guide

Note: A spare Li-ion battery (059-3051-000) or NiMH(059-3054-000) can be charged by placing it directly in the charging port on the back of the cradle. It can be charged at the same time as the instrument. Press the battery in place, sliding it slightly toward the front of the cradle. This locks it in the cradle. To release the battery, slide it forward again and tilt it up.

Note: An Alkaline Battery Adapter (part number 059-3052-000), which uses four AA alkaline batteries (Duracell MN1500), may be substituted for the Li-Ion battery.

WARNING!

To reduce the risk of ignition of hazardous atmospheres, recharge and replace batteries only in areas known to be non-hazardous. Remove and replace batteries only in areas known to be non-hazardous.

1.4 Low Voltage Warning

When the battery's charge falls below a preset voltage, the instrument warns you by beeping once and flashing once every minute, and the battery icon blinks once per second. You should turn off the instrument within 10 minutes and either recharge the battery by placing the instrument in its cradle, or replace the battery with a fresh one with a full charge.

1.5 Clock Battery

An internal clock battery is mounted on one of the instrument's printed circuit boards. This long-life battery keeps settings in memory from being lost whenever the Li-ion, NiMH, or alkaline batteries are removed. This backup battery should last approximately five years, and must be replaced by an authorized RAE Systems service technician. It is not user-replaceable.

WARNING

To reduce the risk of ignition of hazardous atmospheres, recharge battery only in area known to be non-hazardous. Remove and replace battery only in an area known to be non-hazardous.

1.6 Replacing Rechargeable Li-Ion or NiMH Battery

Caution: Turn off the instrument before removing or replacing the battery.

1.7 Alkaline Battery Adapter

An alkaline battery adapter is supplied with each instrument. The adapter (part number 059-3052-000) accepts four AA alkaline batteries (use only Duracell MN1500).

Do not mix old and new batteries or different type batteries.

Troubleshooting

Problem	Possible Reasons & Solutions
Cannot turn on power after charging the battery	<p>Reasons: Discharged battery. Defective battery.</p> <p>Solutions: Charge or replace battery.</p>
Lost password	<p>Solutions: Call Technical Support at +1 408-752-0723 or toll-free at +1 888-723-4800</p>
Reading abnormally High	<p>Reasons: Dirty filter. Dirty sensor module. Excessive moisture and water condensation. Incorrect calibration.</p> <p>Solutions: Replace filter. Blow-dry the sensor module. Calibrate the unit.</p>
Reading abnormally Low	<p>Reasons: Dirty filter. Dirty sensor module. Weak or dirty lamp. Incorrect calibration.</p> <p>Solutions: Replace filter. Remove Calibration Adapter. Calibrate the unit. Check for air leakage.</p>
Buzzer Inoperative	<p>Reasons: Bad buzzer.</p> <p>Solutions: Check that buzzer is not turned off. Call authorized service center.</p>

MiniRAE Lite User's Guide

Inlet flow too low	<p>Reasons: Pump diaphragm damaged or has debris. Flow path leaks.</p> <p>Solutions: Check flow path for leaks; sensor module O-ring, tube connectors, Teflon tube compression fitting. Call Technical Support at +1 408-752-0723 or toll-free at +1 888-723-4800</p>
"Lamp" message during operation	<p>Reasons: Lamp drive circuit. Weak or defective PID lamp, defective.</p> <p>Solutions: Turn the unit off and back on. Replace UV lamp</p>



environmental SCIENCE

AND TECHNOLOGY

www.vironst.com

info@vironst.com

+44(0)1904 373 018

Rev. D
October 2011
P/N 059-4022-001