

**environmental
SCIENCE**

AND TECHNOLOGY

www.environst.com

info@environst.com

+44(0)1904 373 018



MicroRAE™

Wireless Personal Four-Gas Monitor



Rev. B
May 2016
P/N M03-4001-000

Product Registration

Register your product online by visiting:

<http://www.raesystems.com/support/product-registration>

By registering your product, you can:

- Receive notification of product upgrades or enhancements
- Be alerted to Training classes in your area
- Take advantage of RAE Systems special offers and promotions

MicroRAE User's Guide

Contents

1. Standard Contents	10
2. General Information.....	11
3. User Interface.....	12
3.1. Display Overview.....	12
3.1.1. Status Indicator Icons.....	12
3.1.2. Keys & Interface.....	14
3.2. Screen Display For Various Numbers Of Active Sensors	14
3.3. Menus.....	15
3.4. Glance Mode	16
3.5. Panic Alarm.....	16
3.6. Confidence LED.....	16
4. Mesh Wireless Control And Submenus.....	17
5. Battery Charging.....	18
6. External Filter	21
7. Turning The MicroRAE On And Off	22
7.1. Turning The MicroRAE On	22
7.2. Turning The MicroRAE Off	22
7.3. Testing Alarm Indicators.....	23
7.4. Glance Mode	23
7.4.1 Enter Glance Mode	23
7.4.2 Screens	24
7.4.3 Exit Glance Mode	24
8. Modes Of Operation	27
9. Programming.....	27
9.1. Enter Programming In Basic Mode.....	27
9.2. Enter Programming In Advanced Mode	28
9.3. Menus And Submenus	28
9.3.1. Calibration.....	29
9.3.2. Sensor On/Off.....	31
9.3.3. Clear Datalog	31
9.3.4. Monitor Setup	31
9.3.4.1. GPS On/Off.....	31
9.3.4.2. Set User ID.....	31
9.3.4.3. Set Site ID	32
9.3.5. Set Radio.....	32
9.3.5.1. BLE On/Off	32
9.3.5.2. WiFi On/Off.....	32
9.3.5.3. Sent History	32
9.3.5.4. Roaming On/Off	32
9.3.5.5. Radio On/Off	33
9.3.5.6. Set PAN ID	33
9.3.5.7. Set Channel	33
9.3.5.8. Join Network	33
9.3.5.9. Factory Reset	34
9.3.5.10. Exit.....	34

MicroRAE User's Guide

9.4. Parameters Accessed Through ProRAE Studio II.....	35
10. Policy Enforcement.....	37
11. Calibration And Testing.....	40
11.1. Bump Testing And Calibration.....	40
11.1.1. Bump (Functional) Testing (Single Bump or Multi Bump)	41
11.2. Zero Calibration.....	42
11.2.1. Zero Calibration	42
11.2.2. Single-Sensor Zero Calibration	42
11.3. Span Calibration	43
11.3.3 Multi-Sensor Span Calibration	43
11.3.4. Single-Sensor Span Calibration	43
12. Datalog Transfer, Monitor Configuration, and Firmware Upgrades Via Computer ..	45
13. Maintenance	46
14. Alarms Overview	51
15. Troubleshooting	54
16. Diagnostic Mode.....	54
17. Editing Features	56
18. Specifications	58
19. Controlled Part of the Manual for PGM-26XX	62
20. Technical Support	67
21. RAE Systems Contacts	67

MicroRAE User's Guide



This Manual must be carefully read by all individuals who have or will have the responsibility of using, maintaining, or servicing this product. The product will perform as designed only if it is used, maintained, and serviced in accordance with the manufacturer's instructions. The user should understand how to set the correct parameters and interpret the obtained results.

CAUTION!

- Only use the RAE Systems rechargeable lithium-ion battery pack supplied with the instrument.
- Charge the instrument Li-ion battery using the specifically supplied RAE Systems charger and only outside hazardous areas. The maximum voltage from the charger must not exceed 6.0 VDC.
- Any data download device connected to this instrument must be approved SELV or Class 2 equipment.
- Use of non-RAE Systems components will void the warranty and can compromise the safe performance of this product.
- Warning: Substitution of components may impair safe performance of this product.

SPECIAL CONDITIONS FOR SAFE USE

- This multi-gas monitor must be calibrated if it does not pass a bump test, when a new sensor has been installed, or at least once every 180 days, depending on use and sensor exposure to poisons and contaminants
- No precautions against electrostatic discharge are necessary for portable equipment that has an enclosure made of plastic, metal or a combination of the two, except where a significant static-generating mechanism has been identified. Activities such as placing the item on a belt, operating a keypad or cleaning with a damp cloth, do not present a significant electrostatic risk. However, where a static-generating mechanism is identified, such as repeated brushing against clothing, then suitable precautions shall be taken, e.g., the use of anti-static footwear.

Note: Users are recommended to refer to ISA -RP12.13, Part II-1987 for general information on installation, operation, and maintenance of combustible gas detection instruments.

MicroRAE User's Guide

WARNINGS

ONLY THE COMBUSTIBLE GAS DETECTION PORTION OF THIS INSTRUMENT HAS BEEN ASSESSED FOR PERFORMANCE.

UNIQUEMENT, LA PORTION POUR DÉTECTOR LES GAZ COMBUSTIBLES DE CET INSTRUMENT A ÉTÉ ÉVALUÉE.

CAUTION: BEFORE EACH DAY'S USAGE, SENSITIVITY OF THE COMBUSTIBLE GAS SENSOR MUST BE TESTED ON A KNOWN CONCENTRATION OF METHANE GAS EQUIVALENT TO 20 TO 50% OF FULL-SCALE CONCENTRATION. ACCURACY MUST BE WITHIN 0 AND +20% OF ACTUAL. ACCURACY MAY BE CORRECTED BY CALIBRATION PROCEDURE.

ATTENTION: AVANT CHAQUE UTILISATION JOURNALIERE VERIFIER LA SENSIBILITE AVEC UNE CONCENTRATION CONNUE DE METHANE EQUIVALENTE A 20-50% DE LA PLEINE ECHELLE. LA PRECISION DOIT ETRE COMPRISE ENTRE 0-20% DE LA VALEUR VRAIE ET PEUT ETRE CORRIGEE PAR UNE PROCEDURE D'ETALONNAGE.

CAUTION: HIGH OFF-SCALE READINGS MAY INDICATE AN EXPLOSIVE CONCENTRATION.

ATTENTION: DES LECTURES SUPÉRIEURES A L'ÉCHELLE PEUVENT INDIQUER DES CONCENTRATIONS EXPLOSIVES.

MicroRAE User's Guide

Caution:

This device complies with Part 15 of the FCC Rules/Industry Canada license-exempt RSS standard(s). Operation is subject to the following two conditions: (1) this device may not cause harmful interference, and (2) this device must accept any interference received, including interference that may cause undesired operation.

Le présent appareil est conforme aux CNR d'Industrie Canada applicables aux appareils radio exempts de licence. L'exploitation est autorisée aux deux conditions suivantes : (1) l'appareil ne doit pas produire de brouillage, et (2) l'utilisateur de l'appareil doit accepter tout brouillage radioélectrique subi, même si le brouillage est susceptible d'en compromettre le fonctionnement.

Changes or modifications not expressly approved by the party responsible for compliance could void the user's authority to operate the equipment.

This equipment has been tested and found to comply with the limits for a Class B digital device, pursuant to part 15 of the FCC Rules. These limits are designed to provide reasonable protection against harmful interference in a residential installation. This equipment generates, uses and can radiate radio frequency energy and, if not installed and used in accordance with the instructions, may cause harmful interference to radio communications. However, there is no guarantee that interference will not occur in a particular installation. If this equipment does cause harmful interference to radio or television reception, which can be determined by turning the equipment off and on, the user is encouraged to try to correct the interference by one or more of the following measures:

- Reorient or relocate the receiving antenna.
- Increase the separation between the equipment and receiver.
- Connect the equipment into an outlet on a circuit different from that to which the receiver is connected.
- Consult the dealer or an experienced radio/TV technician for help.

Under Industry Canada regulations, this radio transmitter may only operate using an antenna of a type and maximum (or lesser) gain approved for the transmitter by Industry Canada. To reduce potential radio interference to other users, the antenna type and its gain should be so chosen that the equivalent isotropically radiated power (E.I.R.P.) is not more than that necessary for successful communication.

Conformément à la réglementation d'Industrie Canada, le présent émetteur radio peut fonctionner avec une antenne d'un type et d'un gain maximal (ou inférieur) approuvé pour l'émetteur par Industrie Canada. Dans le but de réduire les risques de brouillage radioélectrique à l'intention des autres utilisateurs, il faut choisir le type d'antenne et son gain de sorte que la puissance isotrope rayonnée équivalente (p.i.r.e.) ne dépasse pas l'intensité nécessaire à l'établissement d'une communication satisfaisante.





MicroRAE User's Guide

Product Marking

The MicroRAE (PGM-26XX) is certified according to the IECEx scheme, ATEX and CSA for US and Canada under the intrinsic safety method of protection.

The PGM-26XX is marked with the following information:

RAE SYSTEMS
 3775 N. 1st. St., San Jose
 CA 95134, USA
 Type PGM-26XX
 Serial No/barcode: XXXX-XXXX-XX

IECEx SIR 15.0039X Ex ia d IIC T4 Gb Ex ia I Ma	 0575 SIRA 15 ATEX 2080X  II 2G Ex ia d IIC T4 Gb  I M1 EX ia I Ma	 Cl. I Div. 1, Grps A, B, C, D T-Code T4. C22.2 No.152-M1984 ANSI/ISA-12.13.01-2000 Intrinsically safe/Sécurité intrinsèque
--	--	--

-20° C < Tamb < +60° C

Um: 6V

Battery pack: M03-3004-000

Warning: Substitution of components may impact intrinsic safety.

Avertissement: La substitution de composants peut compromettre la sécurité intrinsèque.

WARNING: Read and understand instruction manual before operation or servicing.

AVERTISSEMENT: Lisez et comprenez le manual d'instructions avant d'utiliser ou service.

WARNING: Substitution of components may impact intrinsic safety.

AVERTISSEMENT: La substitution de composants peut compromettre la sécurité intrinsèque.

WARNING: To prevent ignition of a hazardous atmosphere, batteries must only be charged in an area known to be non-hazardous. Um = 6.0V. Use only approved charger.

AVERTISSEMENT: Afin de prévenir l'inflammation d'atmosphères dangereuse, ne charger le jeu de batteries que dans des emplacement designés non dangereux. Um = 6V
 Utilisez uniquement un chargeur approuvé.

Only use approved battery pack: M03-3004-000.

Only charge the battery in safe area in the ambient temperature range $0^{\circ}\text{C} \leq T_{\text{amb}} \leq 40^{\circ}\text{C}$.

UAE Wireless Approval Marking

TRA
 Model: PGM-2600
 Authorization No: ER46920/16
 Dealer No: DA39257/15

TRA
 Model: PGM-2601
 Authorization No: ER46780/16
 Dealer No: DA39257/15

Proper Product Disposal At End Of Life



The Waste Electrical and Electronic Equipment (WEEE) directive (2002/96/EC) is intended to promote recycling of electrical and electronic equipment and their components at end of life. This symbol (crossed-out wheeled bin) indicates separate collection of waste electrical and electronic equipment in the EU countries. This product may contain one or more Nickel-metal hydride (NiMH), Lithium-ion, or Alkaline batteries. Specific battery information is given in this user guide. Batteries must be recycled or disposed of properly.

At the end of its life, this product must undergo separate collection and recycling from general or household waste. Please use the return and collection system available in your country for the disposal of this product.

Sensor Specifications, Cross-Sensitivities, And Calibration Information

For information on sensor specifications, cross-sensitivities, and calibration information, refer to RAE Systems Technical Note TN-114: Sensor Specifications And Cross-Sensitivities (available for free download from www.raesystems.com). All specifications presented in this Technical Note reflect the performance of standalone sensors. Actual sensor characteristics may differ when the sensor is installed in different instruments. As sensor performance may change over time, specifications provided are for brand-new sensors.

Make Sure Firmware Is Up To Date

For best operation, make sure your monitor is running the latest firmware. Check www.raesystems.com for updates.

MicroRAE User's Guide

1. Standard Contents

The MicroRAE is available in various user-specified configurations, each with the accessories shown below.

In addition to the instrument, the following are included:

Item	Part Number
Travel charger	M03-3005-000
AC adapter	500-0036-102
USB cable	410-0203-000
MicroRAE CD	M03-4005-000
QuickStart guide	M03-4002-000
Calibration cap for diffusion models	M03-3003-000
Warranty card	000-4008-001

2. General Information

The MicroRAE gas monitor combines continuous monitoring capabilities for toxic and combustible gases with Man Down Alarm functionality, BLE (Bluetooth Low Energy), and optional GPS and either WiFi or Mesh Radio wireless connectivity in a compact, portable instrument. It offers a selection of field-replaceable electrochemical and combustible sensors to fit a wide variety of applications. Its wireless capability elevates protection by providing real-time access to instrument readings and alarm status from any location for better visibility and faster response.

2.1. Key Features

- All-in-one continuous monitoring capabilities for oxygen, toxic and combustible gases, for a total of up to four threats at a time
- Wireless access to real-time instrument readings and alarm status from any location
- Local and remote wireless notification of alarm conditions, including Man Down Alarm and location
- GPS functionality to allow better location
- Simple maintenance with easily accessible sensors
- Glance Mode gives quick overview of sensors and wireless configuration

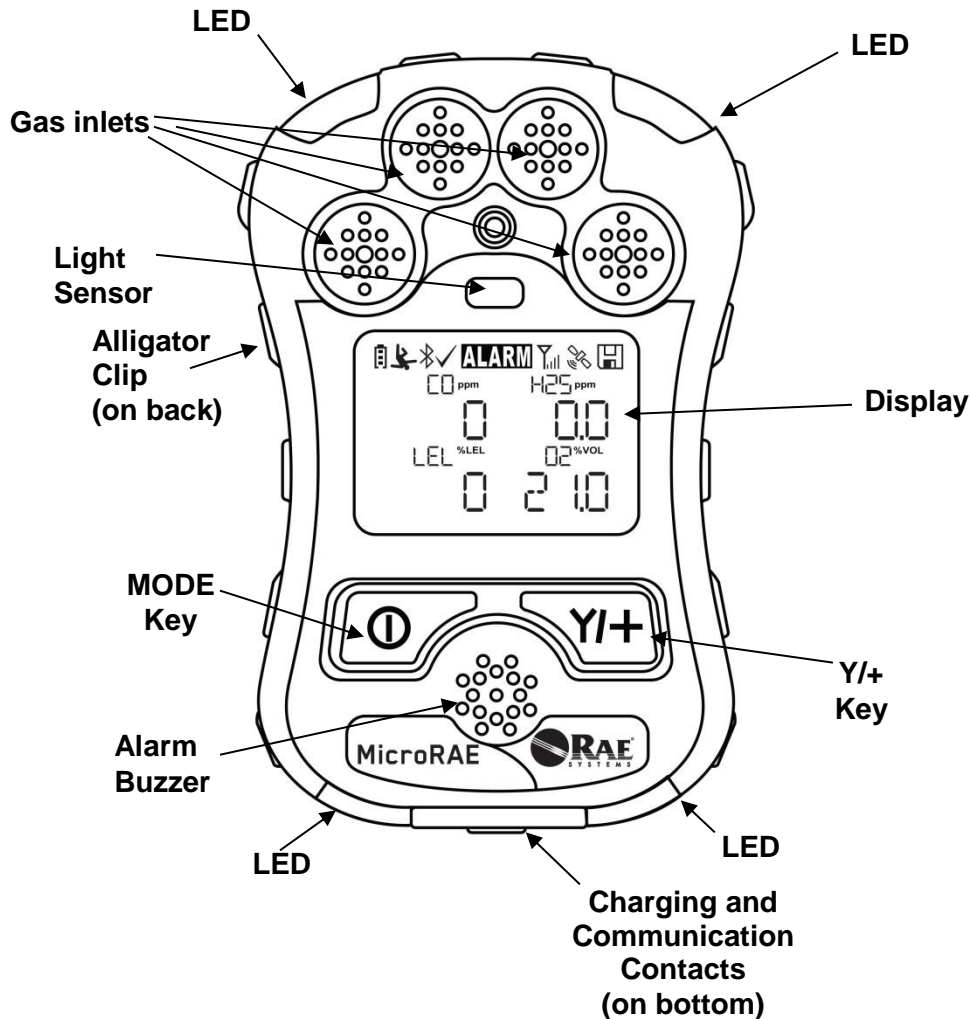

MicroRAE User's Guide

3. User Interface

The MicroRAE's user interface consists of the display, LEDs, an alarm buzzer, and two keys.

3.1. Display Overview

The LCD display provides visual feedback that includes the sensor types, readings, battery condition, and other functions.

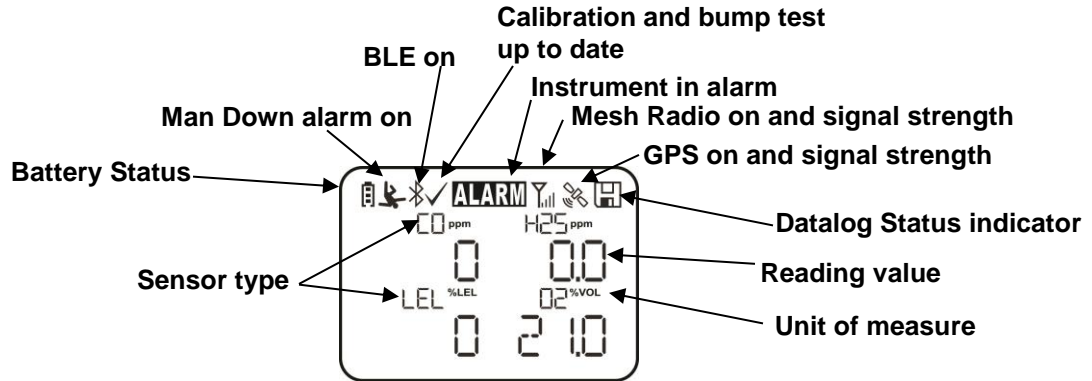













3.1.1. Status Indicator Icons

Along the top of most screens are status indicators that tell you whether a function is operating and/or its strength or level.

Icon	Function
	Mesh and WiFi enabled and power on
	Mesh Radio or WiFi Wireless status: the radio is off (replaced by "R" when Roaming is on).
	Mesh Radio or WiFi Wireless status: the radio is on (replaced by "R" when Roaming is on). Wireless strength is indicated by 0 to 4 bars. Flashing icon without bars indicates network has not been found.
	Cannot find network (blinking icon)
	Mesh Radio & WiFi signal less than 20%
	Mesh Radio & WiFi signal 21% to 50%
	Mesh Radio & WiFi signal 51% to 70%
	Mesh Radio & WiFi signal 71% to 100%
R	Roaming status: "R" blinks when trying to find a network (replaced by antenna when Roaming is off). "R" is solid when network communication established.
R1	Network joined, signal very low RSSI (0% to 19%)

MicroRAE User's Guide

Icon	Function
RiI	Network joined, signal low RSSI (20% to 49%)
RiII	Network joined, signal medium RSSI (50% to 69%)
RiIII	Network joined, signal good RSSI (70% to 100%)
	No radio icon: The instrument is not equipped with a radio module.
	BLE (Bluetooth Low Energy) is on
	GPS Status: off, no satellites found, 1 to 3 satellites, 4 to 8 satellites, 9 to 12 satellites.
	Datalogging status (shown when datalogging is on, blank when off).
	Battery voltage is greater than 70%
	Battery voltage is 41% to 70%
	Battery voltage is 11% to 40%
	Battery voltage is less than 10% (icon blinks)
	Calibration overdue.
	Bump test overdue.
	Man Down alarm enabled.
	All sensors tested and calibrated tick mark (all sensors have been bump tested and calibrated; no sensor is overdue for a bump test or calibration according to the intervals configured on the instrument).
	Go to next page.
ALARM	Instrument is in alarm (flashes)

MicroRAE User's Guide

3.1.2. Keys & Interface

The MicroRAE has two keys:

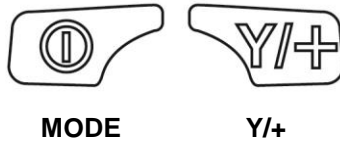

In addition to their labeled functions, the keys labeled [MODE] and [Y/+] act as “soft keys” that control different parameters and make different selections within the instrument’s menus. From menu to menu, each key controls a different parameter or makes a different selection.

In addition to the functions described above, either key can be used to manually activate display backlighting. Press a key when the backlighting is off to turn it on.

3.2. Screen Display For Various Numbers Of Active Sensors

The MicroRAE can accommodate from one to four sensors. When one or more sensors is either not installed or turned off, the display only shows the installed, active sensors:

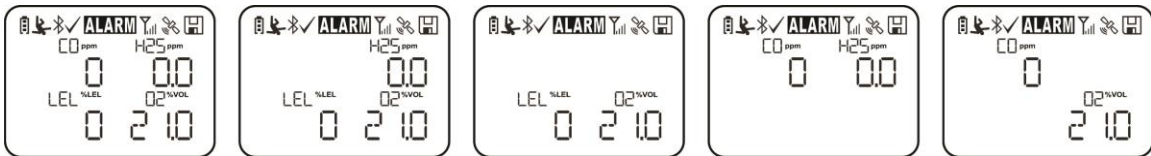

MicroRAE User's Guide

3.3. Menus

The reading menus are easy to step through by pressing the [MODE] and [Y/+] key.

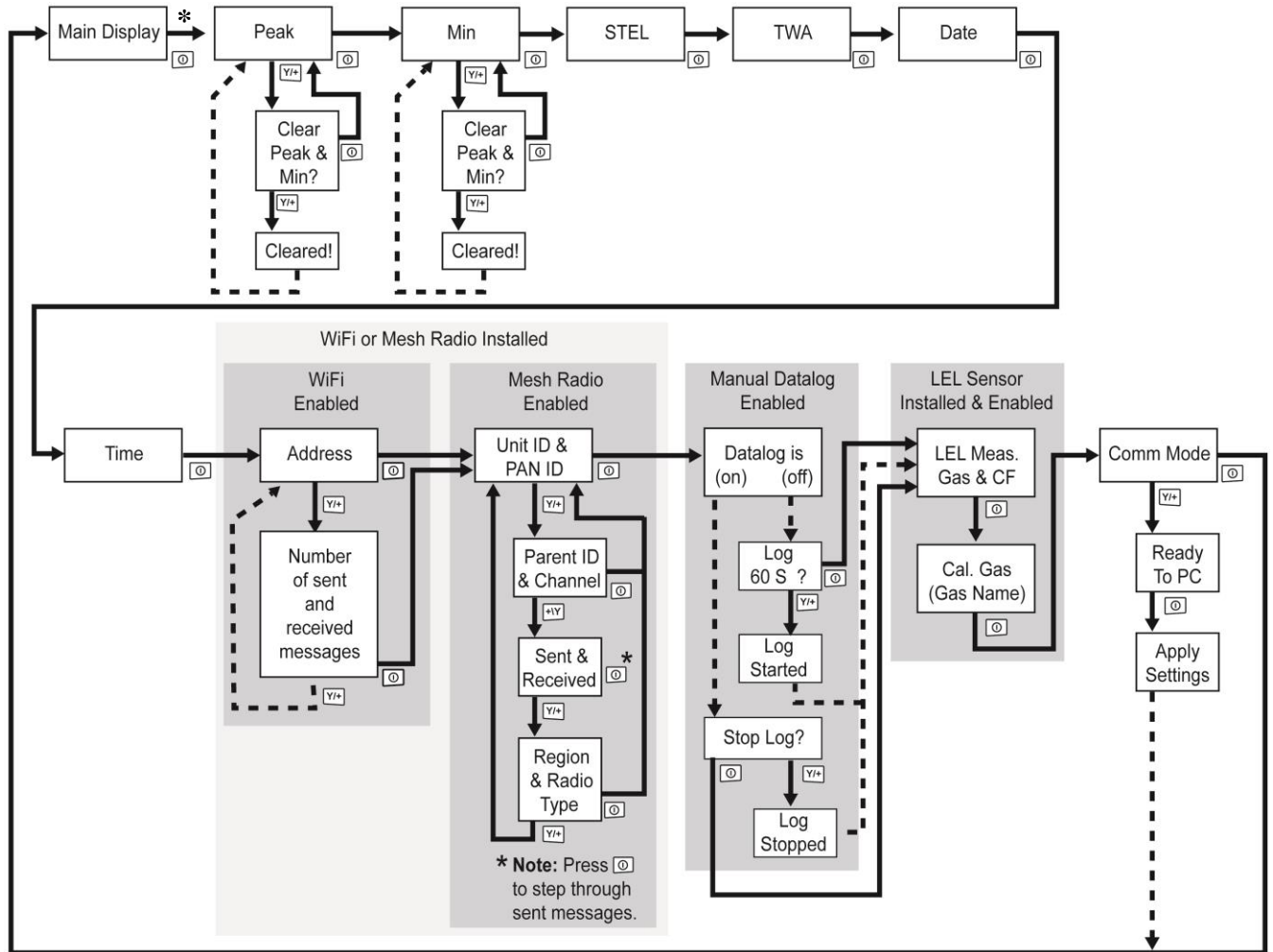

* **If the MicroRAE is WiFi equipped:** WiFi-equipped instruments can receive up to five messages. If a message has been received by the MicroRAE, the number of messages is displayed (1 MSG, etc.). The display shows the message sequentially, cycling through the message each half-second. The Message number, “page” of the message (it automatically breaks a message across screens), and received time and date are shown. Up to five messages can be received by the MicroRAE. Pressing [MODE] steps through the messages. When “Exit” is shown, press [Y/+] to return to the Main Display.

Note: In most cases, if no buttons are pressed at any of the menu steps for 60 seconds, the instrument reverts to the main display.

MicroRAE User's Guide

3.4. Glance Mode

If you want to check your instrument's configuration and it is turned off, you do not have to turn it on. Press and hold [Y/+] until the screen illuminates and shows the configuration. This tells you the installed sensors:



Press [Y/+] to advance through screens that tell you if the radio is on, BLE is on, GPS is on, WiFi is on, etc. These change, depending on the instrument's configuration.

To exit, press [MODE], and the display shuts off.

Note: If you do not press a button for 60 seconds, it turns off automatically.

3.5. Panic Alarm

Press and hold [Y/+] at any time to trigger the Panic Alarm. The display shows "PANIC ALARM" and sends a message to the Location Manager or ProRAE Guardian.

(**Note:** Use ProRAE Studio II to define information and its prioritization for viewing.)

In addition, the instrument alarms (audible and visible) four times per second. The instrument also sends an emergency message to the Location Manager or ProRAE Guardian.



Press [Y/+] to clear the alarm. The alarm stops and the display returns to the main reading screen.

3.6. Confidence LED

You can use ProRAE Studio II to program the MicroRAE to continually provide an LED blink every 3 seconds so that you can tell without looking closely that the instrument is working.

4. Mesh Wireless Control And Submenus

When you step through the main menu, as shown in the Menus diagram, there are four screens for wireless communication, containing information on wireless settings and status. If Roaming is not turned on, then you must set a PAN ID in order to communicate with a Mesh Network.

Note: These are only present if the MicroRAE is equipped with a Mesh Network wireless module.

5. Battery Charging

Always fully charge the battery before using the MicroRAE. Its Li-ion battery is charged by placing the MicroRAE in its Travel Charger (P/N: M03-3005-000) or Charging Cradle. Contacts on the bottom of the instrument meet the Travel Charger's or Charging Cradle's contact pins, transferring power.

Note: Before attaching the MicroRAE to a charger, visually inspect the contacts to make sure they are clean. If they are not, wipe them with a soft, dry cloth. Do not use solvents or cleaners.

WARNING

To reduce the risk of ignition of hazardous atmospheres, recharge, remove or replace the battery only in an area known to be non-hazardous!

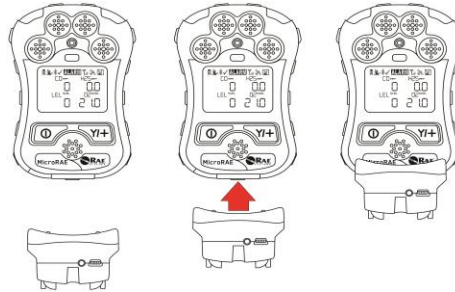

Align the Travel Charger with the middle of the MicroRAE and press it until it is firmly attached.

Next, put the plug from the power supply (P/N: 500-0036-102) into the jack on the side of the Travel Charger.

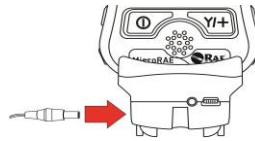

Plug the other end of the charger into a power source (AC outlet or mobile power port in a vehicle, depending on the model). When power is applied and the MicroRAE's battery is charging, the LED glows red. The LED glows green when the battery is fully charged.

Note: For mobile charging, only use Automotive Charging Adapter (P/N 003-3004-000) from RAE Systems.

To remove the MicroRAE from the Travel Charger, squeeze the latches on the sides of the Travel Charger and pull it away from the instrument.

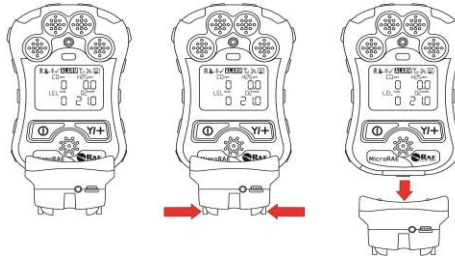

MicroRAE User's Guide

5.1. Charger Station (Multi-Charger)

A Multi Charger (P/N: M03-0300-000) is available for charging up to five MicroRAE instruments at one time. **Note:** It uses a different AC adapter (P/N: 500-0156-000) than the travel charger.



Insert the plug from the power supply into the jack on the side of the Multi Charger:

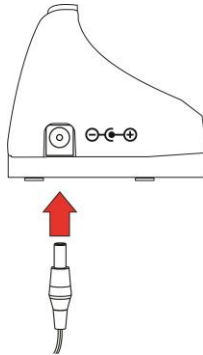

Plug the other end of the charger into a power source.

5.1.1 Charging With The Multi Charger

Press the MicroRAE into any of the Multi Charger's cradles. It should be held firmly in place. If the power is connected to the Multi Charger, the LED indicator on the cradle should glow. When power is applied and the MicroRAE's battery is charging, the LED glows red. The LED glows green when the battery is fully charged.

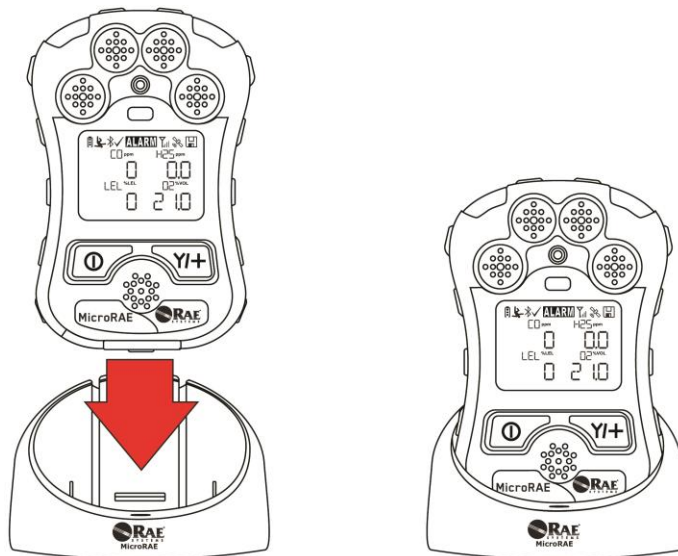

MicroRAE User's Guide



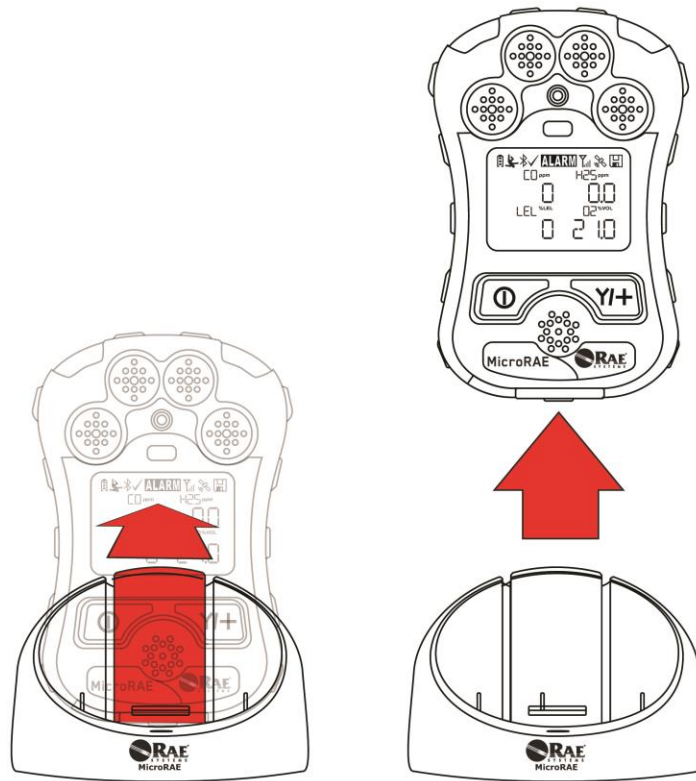

Remove the instrument from the cradle by tilting the release on the rear of the charging cradle away from the instrument and lifting the MicroRAE.



MicroRAE User's Guide

5.2. Battery States

The battery icon on the display shows how much charge is in the battery and alerts you to any charging problems.

			
Battery low	1/3 charge	2/3 charge	Full charge

When the battery's charge falls below a preset voltage, the instrument warns you by beeping once and flashing once every minute. The instrument automatically powers down within 10 minutes, after which you will need to recharge the battery.

6. External Filter

The External Filter (M03-3009-000) is designed to prevent debris from entering the MicroRAE in dirty or dusty environments. Align the filter over the sensor openings and tighten the Philips screw to secure it in place. Replace the filter when it appears dirty.

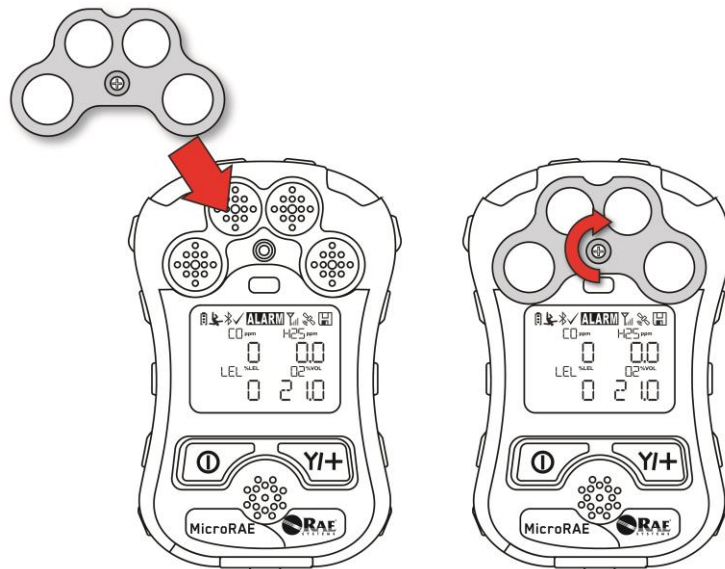

7. Turning The MicroRAE On And Off

7.1. Turning The MicroRAE On

With the instrument turned off, press and hold the [MODE] key until the audible alarm stops, and then release.

When starting up, the MicroRAE turns the backlight on and off, beeps once, blinks once, and vibrates once. A RAE Systems logo should appear first. During a normal startup, this is followed by a progression of screens that tell you the MicroRAE's current settings.

Then the MicroRAE's main reading screen appears. It takes 45 seconds for some sensors to show a reading, so if any have not warmed up by the time the main screen is shown, you will see "--" instead of a numerical value until the sensor provides data (if you turn a sensor off and on again, it also shows "--" for up to 45 seconds). Then it displays instantaneous readings similar to the following screen (depending on the sensors installed) and is ready for use.

Note: If the battery is completely empty, the MicroRAE shuts off. You should charge the before turning it on again.

IMPORTANT!

If a major error that prevents the MicroRAE from functioning is found during startup, the message "Contact Service" is shown on the display. The instrument should be shut off and serviced.

7.2. Turning The MicroRAE Off

Press and hold [MODE]. A 5-second countdown to shutoff begins. You must hold your finger on the key for the entire shutoff process until the MicroRAE is powered off.

Caution: The alarm is very loud. During startup, you can mute most of the sound by holding a finger over the alarm port. Do not put tape over the alarm port to permanently mute it.

7.3. Testing Alarm Indicators

Under normal-operation mode and non-alarm conditions, the buzzer, vibration alarm, LED, and backlight can be tested at any time by pressing [Y/+] once.

IMPORTANT!

If any alarm does not respond, check MicroRAE's alarm settings to make sure all alarms are enabled (selected setting under Programming/Alarms/Alarm Settings should be "All Enabled"). If any alarms are enabled but not functional, the instrument should not be used.

7.4. Glance Mode

Glance Mode allows you to get vital information without turning the MicroRAE on. You can check information such as the instrument's model number, installed sensor types, etc., which may help when taking inventory of instruments and their sensors or when working with service or support personnel. Glance Mode can be enabled/disabled via ProRAE Studio II.

7.4.1 Enter Glance Mode

Note: The instrument must be configured so that Glance Mode is turned on (the default mode is "On"). This can be done in ProRAE Studio II.

With the MicroRAE turned off, press and hold [Y/+] to enter Glance Mode. The feature is latched, meaning that it runs even after you release the [Y/+] key. If you see the message "GLANCE DISABLED," you must configure the instrument to use Glance Mode.

If Glance Mode is enabled, the first screen is displayed. After releasing [Y/+] , other screens release, other screens can be displayed by pressing the [Y/+] Key. In ProRAE Studio II, Glance Mode can be enabled or disabled by checking or unchecking the box labeled "Enable Glance Mode."

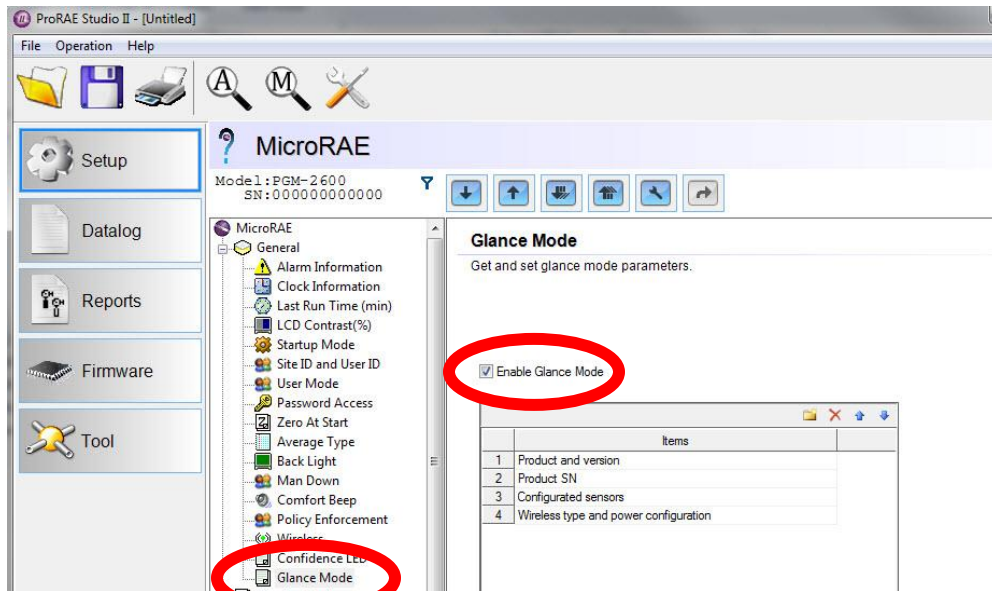

MicroRAE User's Guide

7.4.2 Screens

Every screen displayed in sequence as configuration. Press [Y/+] to advance to the next screen.

Press [MODE] to exit Glance Mode and turn the instrument off. The screens are shown in sequence.

7.4.3 Exit Glance Mode

MicroRAE exits Glance Mode and turns off when you press the [MODE] key. In addition, if you do not press either key in 60 seconds, the MicroRAE automatically exits Glance Mode.

7.5. Comfort Beep

A Comfort Beep is a single beep of the audible alarm at 60-second intervals that provides a reminder that the MicroRAE that it is functioning. It can be turned on or off.

7.6. Man Down Alarm

The Man Down Alarm is a critical and potentially lifesaving safety feature of every MicroRAE. The Man Down Alarm is based on the premise that if the instrument is motionless when it is not supposed to be, something wrong may be happening to its user. If that is the case, the MicroRAE not only goes into alarm locally on the instrument, but also remotely, over a wireless network, to notify people in the vicinity, as well as remote safety officers at a command center, that a person is down, so that help can be dispatched quickly.

Note: Remote notification requires wireless connection to a network.

Whenever the Man Down feature is on, the main screen displays a Man Down icon along the top to indicate it is active:



IMPORTANT!

When gas alarm conditions exist at the same time as the Man Down alarm is activated, the pre-alarm stage is skipped, and the instrument goes straight into Super Alarm (gas and Man Down) with four beeps/flashes per second.

When the Man Down feature is on and there is no gas alarm, the MicroRAE senses that it is motionless for the amount of time set in the “Motionless Time” parameter via ProRAE Studio II. If the instrument is not moved during that time, then a pre-alarm is activated to alert the user, and shows the “OK?” screen. Pressing [Y/+] clears the alarm and returns the MicroRAE to its normal operation. Pressing [MODE] sets it into Man Down Alarm (and if wireless connectivity is enabled, a Man Down message is sent in real time to remote observers). If neither key is pressed, then after the countdown, it goes into Man Down Alarm (again sending a message to remote observers if wirelessly enabled).

Settings are available for:

- Off/On
- Window (time the instrument is motionless before initiating a pre-alarm, in seconds)
- Sensitivity (set to low, medium, or high to compensate for ambient vibration or motion)
- Warning Time (countdown, in seconds, from pre-alarm to Man Down alarm)

MicroRAE User's Guide

When the Man Down alarm is activated, the buzzer sounds and LEDs flash continuously, and a countdown begins.

- If the MicroRAE's user presses [Y/+] for "Yes" in response to the "OK?" question on the screen before the countdown reaches zero, the Man Down alarm stops and the main reading screen is displayed.
- If the person does not press [Y/+] for "Yes" in response to the "OK?" question on the screen before the countdown reaches zero, the Man Down alarm is sounded and LEDs flash continuously.
- If the person presses [MODE] during the countdown, answering the "OK?" question by pressing [MODE] for "No," the Man Down alarm starts.

If wireless connectivity is enabled, and the QRAE 3 is connected to a network, a Man Down message is also sent to remote observers.

7.7. Calibration Status

If any sensor requires calibration, then "Calibration Overdue" icon is shown by the sensor name in the display:

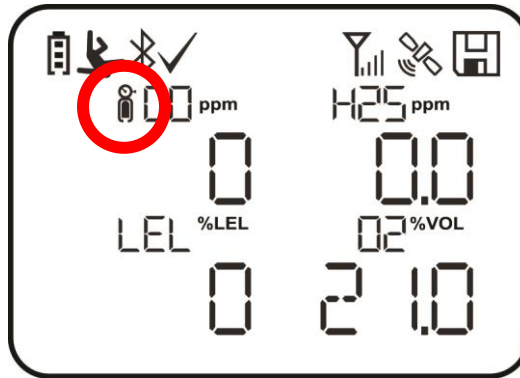

Calibration is required if:

- The sensor module has been replaced with one whose calibration is overdue.
- The defined period of time between calibrations has been exceeded, according to the policy set for the instrument.
- If you have changed the calibration gas type without recalibrating the instrument.
- The sensor has failed a previous calibration.

MicroRAE User's Guide

7.8. Bump Status

If any sensor requires a bump test, then “Bump Overdue” icon is shown by the sensor name in the display:

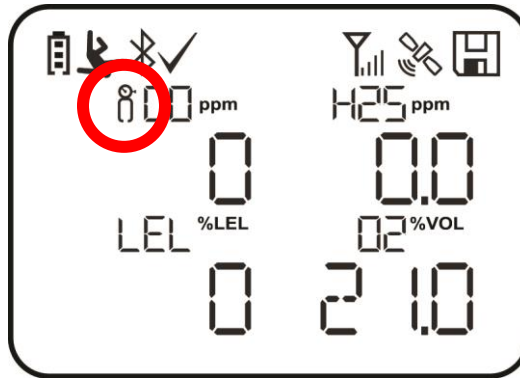

A bump test is required if the defined period of time between bump tests has been exceeded. This interval is set by an administrator using ProRAE Studio II.

8. Modes Of Operation

The MicroRAE has two user modes, selectable through ProRAE Studio II.

8.1. Basic User Mode

In Basic User Mode, some restrictions are applied, including password protection that guards against entering Programming Mode by *unauthorized personnel*.

8.2. Advanced User Mode

In Advanced User Mode, there are no access restrictions (you do not need a password), and the MicroRAE provides the indications and data you need most for typical monitoring applications.

9. Programming

The menu in Programming Mode is to adjust many of the MicroRAE's settings, calibrate sensors, and initiate communication with a computer. It has the following submenus:

- Calibration
- Sensor On/Off
- Clear Datalog
- Monitor Setup
- Set Radio (Wireless)

Note: Some settings are only visible and can only be changed in ProRAE Studio II. This requires connecting the instrument to a computer running ProRAE Studio II and having administrative privileges. For a list of which parameters can be set in Programming Mode on the MicroRAE, in ProRAE Studio II, or both, refer to "Editing Features" on page 56.

9.1. Enter Programming In Basic Mode

1. To enter Programming Mode, press and hold [MODE] and [Y/+] until you see the Password screen.
2. Input the 4-digit password:
 - Increase the number from 0 through 9 by pressing [Y/+].
 - Step from digit to digit using [MODE].
 - After inputting the password's four digits, advance to "?"
 - Press [Y/+] to register the password and enter Programming Mode. If you receive the message "PASS ERR RETRY?" press [Y/+] to re-enter the password. Otherwise, press [MODE] to return to the main screen.

If you make a mistake, you can cycle through the digits by pressing [MODE] and then using [Y/+] to change the number in each position.

Note: The default password is 0000.

Note: The password screen only appears when you enter the Programming Mode the first time after turning the instrument on in Basic Mode. If you have input the correct password, you do not have to input it again to enter Programming Mode until you turn the instrument off and on again.

MicroRAE User's Guide

Once you enter Programming Mode, the Calibration screen is shown. Press [MODE] to step through the programming screens.

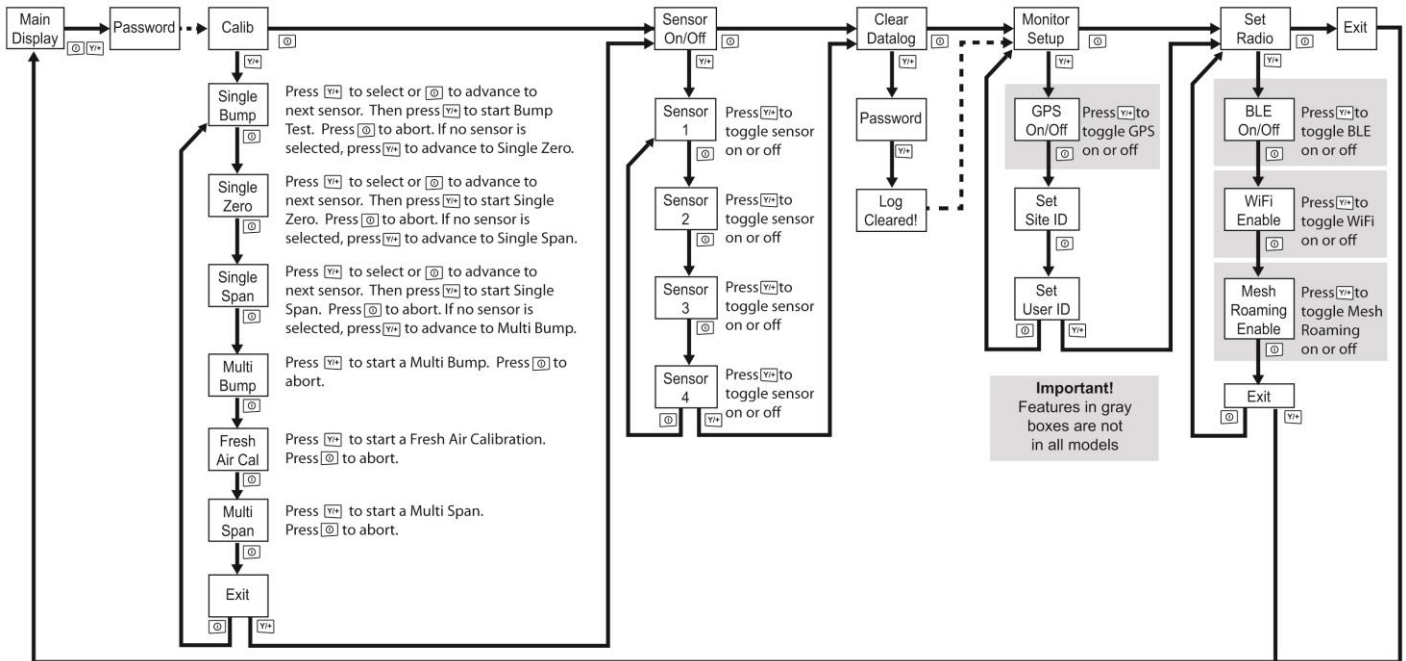

9.2. Enter Programming In Advanced Mode

To enter Programming Mode, press and hold [MODE] and [Y/+] until you see the Calibration screen. No password is necessary in Advanced Mode. **Note:** Some parameters can only be viewed or changed in ProRAE Studio II.

9.3. Menus And Submenus

In Programming Mode, menus and submenus are organized as shown here:

Calibration	Sensor On/Off	Clear Datalog	Monitor Setup	Set Radio
Single Bump	Sensor 1 On/Off		GPS On/Off*	BLE On/Off
Single Zero	Sensor 2 On/Off		Set Site ID	WiFi On/Off**
Single Span	Sensor 3 On/Off		Set User ID	Sent History**
Multi Bump	Sensor 4 On/Off			Mesh Roaming Enable***
Fresh Air Cal				Radio On/Off****
Multi Span				Set PAN ID****
Exit				Set Channel****
				Join Network****
				Factory Reset****
				Exit

- * GPS-equipped version only.
- ** WiFi-equipped version only.
- *** Mesh Wirelessly equipped version only.
- **** Only available if Roaming is turned off.

MicroRAE User's Guide

9.3.1. Calibration

Use this menu to perform zero or span calibration for one or more sensors, and change the gas concentration value assumed to be used in span calibration, as well as zero calibration and calibration reference gas. Refer to “Calibration And Testing” on page 40 for guidance on setting up the instrument for calibration.

9.3.1.1. Single Bump

You can perform a separate bump test on each individual sensor.

The active sensors' names are shown in a list. Press [MODE] to highlight the sensor you want to bump test, and then press [Y/+] to select it.

When the Apply Gas screen is shown, connect the calibration gas to the instrument, and start the bump test by pressing [Y/+]. If you do not want to perform a single bump test, press [MODE] to quit.

Note: You can abort a bump test by pressing [MODE] once testing has started.

When the Multi Bump test is done, a screen is shown, with the sensor names and either “Pass” or “Fail” shown next to them.

9.3.1.2. Single Zero

This allows you to perform zero (fresh air) calibration on individual sensors. For most applications, the instrument should be zero calibrated in clean ambient air with 20.9% oxygen (O₂). For more precise low O₂ percentage accuracy, and after a new O₂ sensor is put into the instrument, zeroing should be performed with nitrogen (N₂). A zero calibration should precede a span calibration.

The active sensors' names are shown in a list. Press [MODE] to highlight the sensor you want to zero calibrate, and then press [Y/+] to select it.

When the Zero Calibration screen is shown with the sensor name and its measurement unit, start the zero calibration by pressing [Y/+]. If you do not want to perform a calibration, press [MODE] to quit.

Note: You can abort a zero calibration by pressing [MODE] once testing has started.

When the zero calibration is done, the Calibration Results screen is shown with either “Pass” or “Fail” shown.

9.3.1.3. Single Span

Instead of performing a span calibration on more than one sensor simultaneously, you can select a single sensor and perform a span calibration.

The active sensors' names are shown in a list. Press [MODE] to highlight the sensor you want to span calibrate, and then press [Y/+] to select it.

When the Apply Gas screen is shown with the sensor name and its measurement unit, connect a cylinder of span gas, start its flow, and then start the span calibration by pressing [Y/+]. If you do not want to perform a span calibration, press [MODE] to quit.

MicroRAE User's Guide

Note: You can abort a span calibration by pressing [MODE] once testing has started.

When the span calibration is done, the Calibration Results screen is shown with either “Pass” or “Fail” shown.

9.3.1.4. Multi Bump

Depending on the configuration of your MicroRAE and the span gas you have, you can perform a bump test simultaneously on multiple sensors.

The selected sensors and their values are shown on the screen. With calibration gas connected to the instrument, start a multiple bump test by pressing [Y/+]. If you do not want to perform a multiple bump test, press [MODE].

Note: You can abort a multiple bump test by pressing [MODE] once testing has started.

When the Multi Bump test is done, a screen is shown, with the sensor names and either “Pass” or “Fail” shown next to them.

9.3.1.5. Fresh Air Calibration

You can perform a fresh air calibration simultaneously on multiple sensors. This procedure determines the zero point of the sensor calibration curve for all the sensors that require a zero calibration. The instrument should be zero calibrated in clean ambient air with 20.9% oxygen. A fresh air calibration should precede a span calibration.

The selected sensors are shown on the screen. Start a multiple zero test by pressing [Y/+]. If you do not want to perform a test, press [MODE].

Note: You can abort a multiple zero test by pressing [MODE] once testing has started.

When the Multi Zero test is done, a screen labeled Calibration Results is shown, with the sensor names and either “Pass” or “Fail” shown next to them.

9.3.1.6. Multi Span

Depending on the configuration of your MicroRAE and the span gas you have, you can perform a span calibration simultaneously on multiple sensors.

The selected sensors and their values are shown on the screen. With calibration gas connected to the instrument and turned on, start a multiple span calibration by pressing [Y/+]. If you do not want to perform a multiple span calibration, press [MODE].

Note: You can abort a multiple span calibration by pressing [MODE] once testing has started.

When the Multi Span calibration is done, a screen labeled Calibration Results is shown, with the sensor names and either “Pass” or “Fail” shown next to them.

9.3.1.7. Exit

Exit to “Sensor On/Off”: Press [Y/+].

Return to the top item in the Calibration menu, “Single Bump”. Press [MODE].

MicroRAE User's Guide

9.3.2. Sensor On/Off

You can turn sensors on or off via this set of submenus. The word “ON” or “OFF” below each sensor’s name tells you its status.

1. Press [MODE] to advance through the sensors.
2. Press [Y/+] to turn a selected sensor on or off.
3. Press [MODE] until “?” is selected.
4. Press [Y/+] to save your selection and exit to “Clear Datalog”. Otherwise, to return to the first sensor, press [MODE].

9.3.3. Clear Datalog

The instrument displays a floppy disk icon to indicate that a datalog is being recorded. The instrument stores the measured gas concentration for each sensor, date and time for each measurement, Site ID, User ID, and other parameters. All data are retained (even after the unit is turned off) in non-volatile memory so that they can be downloaded at a later time to a PC.

Clearing the datalog erases all data stored in the datalog.

IMPORTANT!

Once the datalog is cleared, the data cannot be recovered.

Note: The datalog is password protected. You must enter the correct password in order to clear the datalog.

1. Enter the password (the default value is 0000).
2. Press [Y/+] .

The message “Log Cleared!” appears briefly on the screen before advancing to “Monitor Setup.”

9.3.4. Monitor Setup

The Monitor Setup menu provides access to settings for GPS, Site ID, and User ID.

9.3.4.1. GPS On/Off

If your MicroRAE is equipped with GPS, you can turn it on or off:

1. Press [Y/+] to enter “GPS On/Off”.
2. Press [Y/+] to turn GPS on or off.
3. Press [MODE] to save your choice and advance to “Set Site ID”.

9.3.4.2. Set User ID

If your MicroRAE is to be used by a specific user, it can have a uniquely named User ID (a name or numbers or combination) to help identify it in ProRAE Guardian monitoring software. The User ID must be eight alphanumeric characters.

1. Press [MODE] to advance through the characters from left to right.
2. Press [Y/+] to advance through the letters and numbers (1, 2, 3, A, B, C, etc.).
3. Press [MODE] to register your choice and advance to the next character.
4. When you are satisfied with the Site ID, press [MODE] until “?” is selected.

MicroRAE User's Guide

5. Press [Y/+]. The Site ID is saved, and you see the confirmation message “User ID Saved.” It automatically advances to “Exit.”
6. Press [Y/+] to exit to “Set Radio.” To return to the Set Site ID, press [MODE].

9.3.4.3. Set Site ID

If your MicroRAE is to be used at a specific site, it can have a uniquely named Site ID (a name or numbers or combination) to help identify it in ProRAE Guardian monitoring software. The Site ID must be eight characters in length, with the first four characters alphanumeric (letters and numerals) and the last four must be numerals.

1. Press [MODE] to advance through the characters from left to right.
2. Press [Y/+] to advance through the letters and numbers.
3. Press [MODE] to register your choice and advance to the next character.
4. When you are satisfied with the Site ID, press [MODE] until “?” is selected.
5. Press [Y/+]. The Site ID is saved, and you see the confirmation message “Site ID Saved.” It automatically advances to “Set User ID.”

9.3.5. Set Radio

Depending on which (if any) radio type is installed in the MicroRAE, there are various settings that can be changed.

Note: BLE (Bluetooth Low Energy) is included in all MicroRAEs.

9.3.5.1. BLE On/Off

You can turn BLE in all configurations of MicroRAE, or turn WiFi or Mesh Roaming (depending on how your instrument is configured) on or off via this set of submenus.

1. From “Set Radio,” press [Y/+] to advance to BLE On/Off.
2. Press [Y/+] to turn BLE on or off, or press [MODE] to advance to the next “Set Radio” screen without changing the BLE on/off status.

9.3.5.2. WiFi On/Off

If your MicroRAE is equipped with WiFi wireless, you can turn it on or off:

Press [Y/+] to toggle WiFi on or off, or press [MODE] to advance to any other radio type's on/off screen without changing the WiFi on/off status.

9.3.5.3. Sent History

If your MicroRAE is equipped with WiFi wireless, you can view messages that have been sent from the MicroRAE (messages must be created in ProRAE Studio II and loaded into the MicroRAE):

Press [Y/+] to view sent messages. If none have been sent, then “No Msg” is shown.

9.3.5.4. Roaming On/Off

The Roaming function provides continuous wireless connectivity between zones, enabling users of wireless monitors to travel from one zone/work area to another without losing communication between their monitor and ProRAE Guardian. You can turn Roaming on and off in ProRAE Studio II.

1. Press [MODE] to toggle Roaming “On” or “Off.”

MicroRAE User's Guide

2. Press [MODE] to scroll to “Exit.”
3. Press [Y/+] to exit.

9.3.5.5. Radio On/Off

This is only available if your MicroRAE is configured with WiFi or Mesh Radio.

Press [Y/+] to turn the radio on or off, or press [MODE] to advance to the next screen without changing the radio's on/off status.

9.3.5.6. Set PAN ID

This is only available if your MicroRAE is configured with Mesh Radio.

1. Press [MODE] to advance through the numbers from left to right.
2. Press [Y/+] to advance through the numbers (1, 2, 3, etc.).
3. Press [MODE] to register your choice and advance to the next number.
4. When you are satisfied with the PAN ID, press [MODE] until “?” is selected.
5. Press [Y/+] . The PAN ID is saved, and you see the confirmation message “Apply Settings”. It automatically advances to “Apply Success”. After 1 second, it automatically advances to “Set Channel.”

9.3.5.7. Set Channel

This is only available if your MicroRAE is configured with Mesh Radio.

The MicroRAE and any other devices that you want to connect wirelessly must be operating on the same channel.

Note: For radio modems operating at 868MHz, only channel 0 is available. For other frequencies, channels 1 through 10 are allowed.

1. Press [MODE] to advance through the numbers from left to right.
2. Press [Y/+] to advance through the numbers (1, 2, 3, etc.).
3. Press [MODE] to register your choice and advance to the next number.
4. When you are satisfied with the channel number, press [MODE] until “?” is selected.
5. Press [Y/+] . The Site ID is saved, and you see the confirmation message “Apply Settings” followed by “Apply Success”. It automatically advances to “Join Network”.

9.3.5.8. Join Network

This is only available if your MicroRAE is configured with WiFi or Mesh Radio.

You can tell the MicroRAE to automatically join a network. The PAN ID and Channel are shown for reference (if either is incorrect, you can change it, as described above). Press [Y/+] to join or [MODE] to advance to “Interval” without making a change. **Note:** If Roaming is turned on, instead of a PAN ID number, you see “- -”.

Press [Y/+] to join a network.

The PAN ID and channel are shown. To join, press [Y/+] . To exit to the “Factory Reset,” press [MODE].

MicroRAE User's Guide

While it is searching for a network to join, the display shows this message:



If it is unsuccessful, the display shows this message:



Check your other settings, as well as those of the network you are trying to join.

You can press [Y/+] to retry or [MODE] to exit without joining a network.

9.3.5.9. Factory Reset

Restore all the wireless settings to their original factory defaults.

Caution! Once you reset the wireless settings, you cannot retrieve any of the settings deleted by performing this reset.

Press [Y/+] to initiate a factory reset. You see this screen:

Reset Radio?

- Press [Y/+] to reset the wireless settings. You see the message “Pls Wait” while it resets to factory settings. When it is done it shows the PAN ID and Channel.
- Press [MODE] to exit.

9.3.5.10. Exit

Exit to the main reading screen: Press [Y/+].

Return to the top of the “Set Radio” menu: Press [MODE].

9.4. Parameters Accessed Through ProRAE Studio II

Some parameters can be accessed through the menus in the MicroRAE, but some can only be viewed and set in ProRAE Studio II.

9.4.1.1. Alarm Mode

You can program the MicroRAE so that there are two ways to shut off an alarm:

Auto Reset	When the alarm condition is no longer present, the alarm stops and resets itself.
Latch	The latched setting only controls alarms for High Alarm, Low Alarm, STEL Alarm, and TWA alarm. When an alarm is in "latched" mode, the alarm signal remains on even when the alarm condition is no longer present Press [Y/+] to acknowledge and reset alarm signals.

9.4.1.2. Alarm Settings

You can enable/disable any combination of light (LEDs), buzzer, and vibration alarms.

Settings:

- All Enabled
- Lights Only
- Vibration Only
- Buzzer Only
- Buzzer & Light
- Buzzer & Vibration
- Vibration & Light
- All Disabled

9.4.1.3. Clock Information

Set the date and time manually or check the checkbox to synchronize with your PC.

Date

Month (MM) and Day (DD) have two digits each, while the year (YYYY) uses four digits.

Time

The time must be set using the 24-hour format, following hours, minutes, and seconds (HH:MM:SS).

9.4.1.4. Last Run Time (min)

This read-only parameter tells how long the MicroRAE ran during its last session.

9.4.1.5. LCD Contrast (%)

The display's contrast can be increased or decreased from its default setting. You may not need to ever change the default setting, but sometimes you can optimize the display to suit extreme temperature and ambient brightness/darkness conditions. Its midpoint is 50%.

MicroRAE User's Guide

9.4.1.6. Startup Mode

You can choose Normal or Fast startup. Normal startup shows more information during the startup process, but Fast shows fewer and therefore gets from power-on to reading more quickly.

9.4.1.7. Password Access

View or change the password. The default value is "0000." It must have four digits.

9.4.1.8. Zero At Start

If your MicroRAE has been configured to perform a zero (fresh air) calibration upon startup, called Zero At Start, then the startup routine is interrupted so that you can perform a fresh air calibration. Choices are On or Off.

9.4.1.9. Average Type

Get or set the instrument's averaging type. These include Moving Average, TWA Average, and No Average Operation.

9.4.1.10. Back Light

The display's backlight can be set to illuminate either automatically, based on ambient light conditions, or manually, or it can be shut off. In addition, you can view or change the Back Light Trigger Value.

9.4.1.11. Messaging

Get or set pre-configured messages (maximum length is 20 characters, including spaces or symbols).

9.4.1.12. Datalog Options

Data Selection. Get or set the MicroRAE's data type. Options include Minimum, Average, Maximum, and Real Time.

Log Mode. Get or set the instrument's log mode. Options include Datalog Start Type and Memory Full Action

Log Interval. Get or set the log interval (in seconds).

9.4.1.13. Gas Information

Gas Library Information. The current gas library's information is shown, including its version, date, time, and total number of gases included in it. These are tailored to the sensors for best accuracy.

Custom Gas List. Get and set custom gases in the instrument's library. You can provide a name, formula, gas number, and parameters such as molecular weight, Correction Factor (CF), alarms and Span value.

MicroRAE User's Guide

9.4.1.14. Sensor Information

Sensor Summary. View installed and enabled sensors, and set whether a sensor is enabled or disabled.

Sensor data is included for each sensor below Sensor Summary. Everything you need to know about a sensor is shown, plus you can set Bump Test and Calibration Intervals, Span and applicable Alarms, plus Calibration Gas and Measurement Gas.

Sensor Alarm. Get or set the sensor alarm parameters. For each sensor, you can set High Alarm, Low Alarm STEL Alarm (if applicable), and TWA Alarm (if applicable).

Sensor Span. Get or set the sensor span gas concentrations.

Sensor Bump Test. Get or set the sensor bump test parameters. This includes setting the interval (number of days) for bump testing.

Multi-Calibration. You can select which sensors you want included when you perform a Multi Calibration. Use the check boxes to make your selections.

Sensors to Log. You can select which sensors you want included in your datalogs. Use the check boxes to make your selections.

Sensor Maintenance. After a new sensor is installed, list its name and serial number.

10. Policy Enforcement

The MicroRAE can be configured via ProRAE Studio II to enforce a facility/company's requirements that calibration and/or bump testing be performed at specified intervals, and to warn the user that calibration/bump testing is required. In addition, it can require calibration or bump testing and not allow normal operation of the instrument unless calibration or bump testing is performed.

If Policy Enforcement is enabled and if the instrument has been bump tested and calibrated in compliance with the policy settings, a check-mark icon is included along the top of the MicroRAE screen:



If Policy Enforcement is enabled, then after startup the MicroRAE displays a screen that informs the user that the instrument requires either a bump test or a calibration. If both are required, then they are shown in sequence.

MicroRAE User's Guide

10.1. Setting Policy Enforcement

You must use ProRAE Studio II to make changes to Policy Enforcement settings.

Make sure the AC adapter is connected and that a USB cable is connected between the Travel Charger and a computer running ProRAE Studio II.

1. Turn on the MicroRAE. Allow the system to start up and go through its startup routine.
2. Press [MODE] until “Comm Mode?” is displayed.
3. Press [Y/+]. The screen now displays: “Ready To PC”.
4. Start ProRAE Studio II.
5. Select “Administrator.”
6. Input the password (the default is “rae”).
7. Click “OK.”
8. Click “A” (detects instruments automatically).
9. Click on the instrument's icon when it appears to highlight it.
10. Click “Select.”
11. Click “Setup.”
12. Click “Policy Enforcement.”

The Policy Enforcement pane is shown:

Policy Enforcement
Get and set the unit's policy enforcement feature

Must Calibrate

Can't Bypass

Can Bypass

Must Bump

Can't Bypass

Can Bypass

You can select “Must Calibrate” and/or “Must Bump” and then set whether the user must perform the selected operation in order to use the instrument.

MicroRAE User's Guide

13. Once you have made your selections in ProRAE Studio II, you must upload the changes to the instrument. Click the icon labeled "Upload current settings to the instrument."



14. A confirmation screen is shown. Click "Yes" to perform the upload, or "No" to abort.

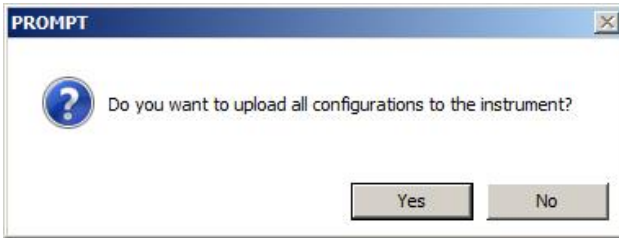

Uploading takes a few seconds, and this progress bar is shown. You can abort the upload by clicking "Cancel."

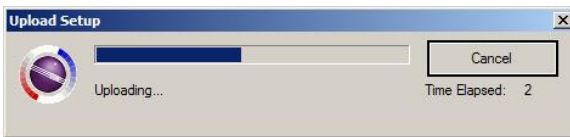

15. Exit ProRAE Studio II.
16. Press [MODE] on the MicroRAE to apply settings and exit Communication Mode.

11. Calibration And Testing

11.1. Bump Testing And Calibration

RAE Systems recommends that a bump test be conducted periodically on the MicroRAE. The purpose of a bump test is to ensure that the instrument's sensors respond to gas and all the alarms are enabled and functional.

- The MicroRAE multi-gas detector must be calibrated if it does not pass a bump test, or at least once every 180 days, depending on use and sensor exposure to poisons and contaminants.
- Calibration intervals and bump test procedures may vary due to national legislation.

A bump test can be performed either manually or using the AutoRAE 2 Automatic Test and Calibration System. When a bump test is done manually, the instrument makes a pass/fail decision based on sensor performance, but the user still has the responsibility to make sure all the alarms are enabled and functional.

Note: Bump testing and calibration can be performed using an AutoRAE 2 Automatic Test & Calibration System. An AutoRAE 2 bump test takes care of both the sensor and alarm tests. Consult the AutoRAE 2 User's guide for details.

MicroRAE User's Guide

11.1.1. Bump (Functional) Testing (Single Bump or Multi Bump)

The same gas is used for a bump test as for calibration. A constant-flow regulator producing 0.5 liters per minute (1 liter per minute for HCN sensors) should be used, and the calibration adapter must be installed. The instrument must be connected to a cylinder of calibration gas with supplied tubing.

1. Turn on your MicroRAE by pressing and holding the [MODE] key, and allow the instrument to boot up fully until the main measurement screen with sensor names and readings is shown.

Important! Make sure all of the instrument's sensors have warmed up before performing a bump test. The instrument will take the time to warm up the sensors prior to enabling access to bump test menus. You can tell a sensor has warmed up if you see a reading next to its name on the display. If it has not warmed up, you see three dashes (“--”) next to it.

2. Install the calibration adapter on the MicroRAE by setting it on over the sensors and turning the knob until it is snug against the surface of the instrument.

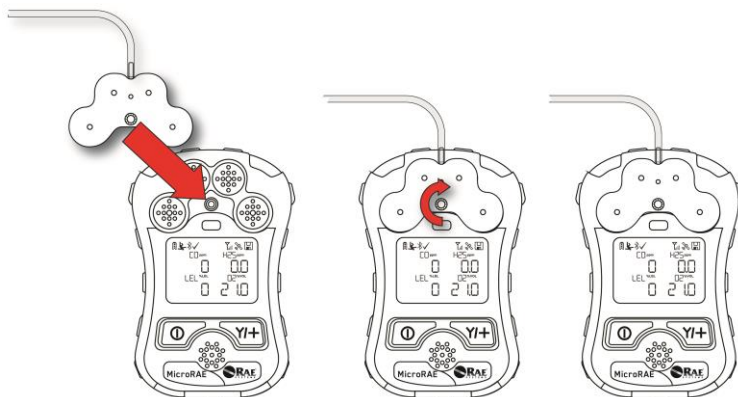

3. Turn on the gas to initiate flow.

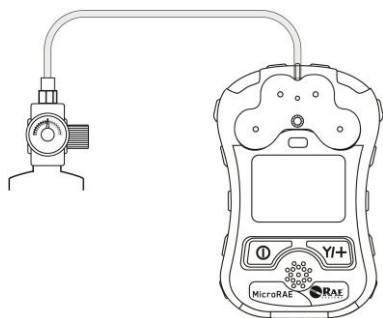

4. Connect the calibration adapter to the calibration gas.
5. Press Start ([Y/+] key) to start the bump test, or press [MODE] to quit. While the bump test is being performed, the readings for each sensor are shown. Once the bump test completes, pass/fail test results and readings are shown for each sensor.

Important! If one or more sensors fails a bump test, be sure to calibrate those sensors.

MicroRAE User's Guide

6. The bump test is now complete. Press [MODE] to exit to the next bump or calibration type in the Calibration menu. (Press [MODE] several times until you see "Exit," and then press [Y/+] to continue through other menu options.

If all the alarms and all sensors have passed and no sensor is due for a calibration, the instrument is now ready for use.

11.2. Zero Calibration

This operation sets the zero point of the sensor calibration curve for clean air. It should be performed before other calibrations.

Note: If you use a zero air cylinder, you must use the MicroRAE Calibration Adapter. Using a calibration adapter is not necessary for calibration in fresh air.

11.2.1. Zero Calibration

This procedure determines zero points of most sensors. The MicroRAE should be zero-calibrated in clean air with 20.9% oxygen or with a cylinder of clean zero air.

At the Calibration menu, select "Fresh Air" by pressing [Y/+] once to enter fresh air calibration.

After a timer countdown, the zero calibration is done. The LCD displays the sensor names and tells you whether each calibration passed or failed, followed by the sensor readings.

Note: You can abort the calibration at any time during the countdown by pressing [MODE].

11.2.2. Single-Sensor Zero Calibration

Select the sensor and then start the calibration by pressing [Y/:]. You can abort the procedure anytime by pressing [MODE].

11.3. Span Calibration

This procedure determines the second point of the sensor calibration curve for the sensor.

Note: When a manual calibration is performed, the readings shown are in the equivalent units of the calibration gas, and not the measurement gas. When performing a Span calibration, the Calibration Adapter must be used for supplying calibration gas to all sensors at one time:

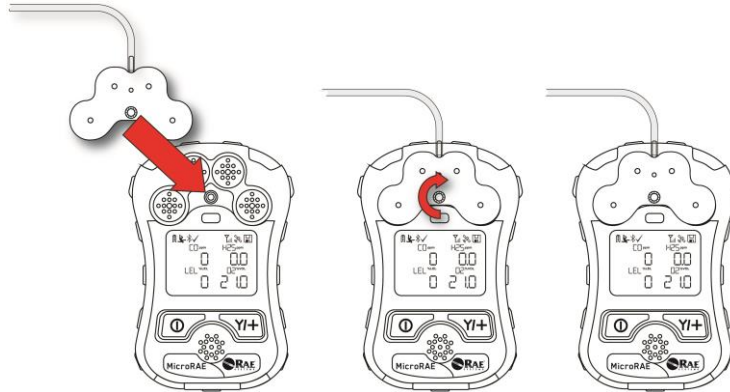

1. Align the Calibration Adapter's main body with the indented area around the MicroRAE's gas inlets.
2. Turn the knob clockwise to secure the Calibration Adapter to the instrument.
3. Connect the hose to the Calibration Adapter and to its gas source.
4. Make sure the Calibration Adapter is securely attached before starting the flow of calibration gas. (The Calibration Adapter has small grooves on its underside to allow gas to escape after passing over the sensors.)

11.3.3 Multi-Sensor Span Calibration

This lets you perform a span calibration on multiple sensors simultaneously. It requires using the appropriate span gas and that the concentration labeled on the gas cylinder matches the concentration programmed in the MicroRAE.

1. Start the flow of calibration gas.
2. Attach the calibration adapter and gas to the MicroRAE.
3. Press [Y/+] to begin calibration. A countdown screen is shown. You can abort the calibration at any time during the countdown by pressing [MODE].

If the calibration reaches its conclusion, it shows the sensor names and tells you whether the calibration passed or failed, followed by the sensor readings.

11.3.4. Single-Sensor Span Calibration

To perform span calibration of an individual sensor, follow these steps:

1. At the Calibration Menu, select "Single Sensor Span."
2. Select a sensor from the list.
3. Start the flow of calibration gas.
4. Connect the calibration adapter and connect it to a source of calibration gas.
5. Verify that the displayed calibration value meets the concentration label on the gas cylinder.

MicroRAE User's Guide

6. Press [Y/+] to start calibrating. You can abort the calibration at any time during the countdown by pressing [MODE].

After a timer countdown, the span calibration is done. The LCD will display whether the calibration was successful and the reading for that calibration gas.

Note: If the sensor calibration fails, try again. If calibration fails again, turn off the power and then replace the sensor.

WARNING: Do not replace sensors in hazardous locations

12. Datalog Transfer, Monitor Configuration, and Firmware Upgrades Via Computer

Note: Basic functionality can be adjusted via the MicroRAE's interface, but more extensive functionality and parameters can be adjusted using ProRAE Studio II software.

Datalogs can be downloaded from the MicroRAE to a computer, and firmware updates can be uploaded to the MicroRAE via the USB port on the Travel Charger. Use the included Mini B USB (5-pin)-to-USB cable to connect the Travel Charger to a computer running ProRAE Studio II (version 1.10.0 or higher).

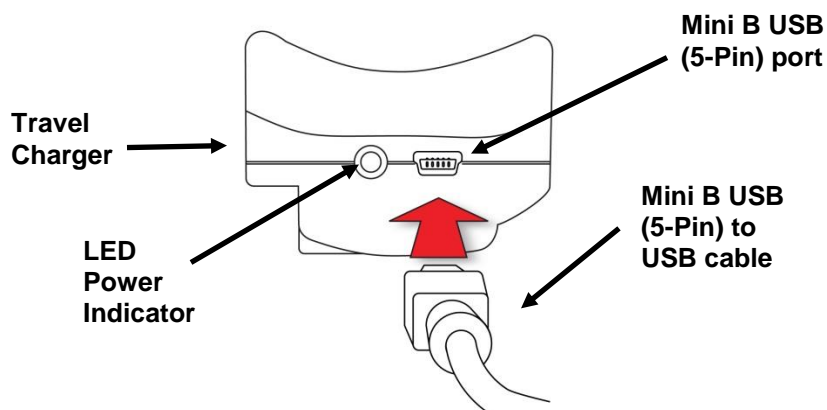

12.1. Downloading Datalogs And Performing PC-Based Instrument Configuration and Firmware Upgrades

The MicroRAE communicates with a PC running ProRAE Studio II Instrument Configuration and Data Management software to download datalog, configure the instrument, or upload new firmware.

The MicroRAE must be connected to a PC through the supplied Travel Charger and must be in the PC communications mode.

1. Use the supplied PC Communications Cable (USB to mini-USB cable) to connect the Travel Charger to a PC.
2. Turn on the MicroRAE. Make sure it is running (with the main measurement screen showing).
3. Activate the PC communications mode on the MicroRAE by pressing [MODE] repeatedly, starting from the main measurement screen until you reach the "Comm Mode" screen.
4. Press [Y/+]. Measurement and datalogging stop, and the instrument is now ready to communicate with the PC. The display now says "Ready To PC".
5. Start up the ProRAE Studio II software, enter a password, and detect the instrument following the directions provided in the ProRAE Studio II User's Guide.
6. Follow the instructions in the ProRAE Studio II User's Guide to download the datalog, configure the instrument settings, or update the MicroRAE's firmware.
7. When you are done, press [MODE] to exit the PC communications mode on the MicroRAE.

Note: After upgrading the MicroRAE's firmware, the instruments will turn off automatically.

13. Maintenance

The MicroRAE requires little maintenance, aside from replacing sensors.

IMPORTANT!

RAE Systems by Honeywell cannot guarantee the IP rating of an instrument that has been opened.

13.1. Removing Sensors

WARNING! Do not replace sensors in hazardous locations.

All sensors are located inside the sensor compartment in the upper half of the MicroRAE. To access the sensors:

1. Turn off the instrument.
2. Remove the four screws in the back of the instrument.
3. Turn the instrument over.
4. Lift off the front cover from the back of the instrument.

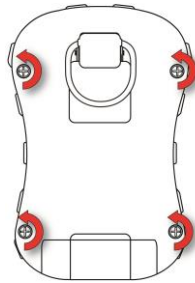

5. Carefully lift out each sensor you wish to inspect or replace.

Note: Oxygen and toxics sensors are labeled on their sides. The sockets are also labeled.

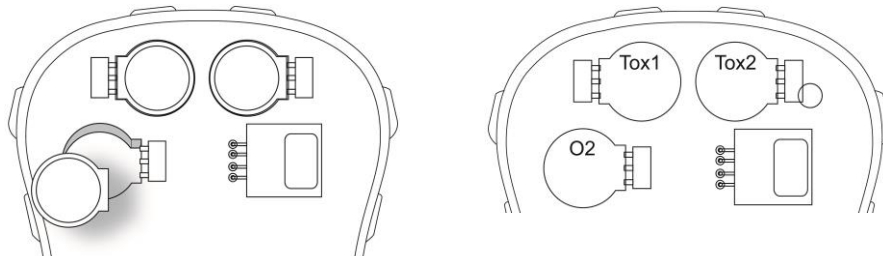

MicroRAE User's Guide

The LEL sensor is square and has four pins that insert into four plated holes in the PC board. When removing or installing an LEL sensor, lift it straight out and be careful not to bend the pins.

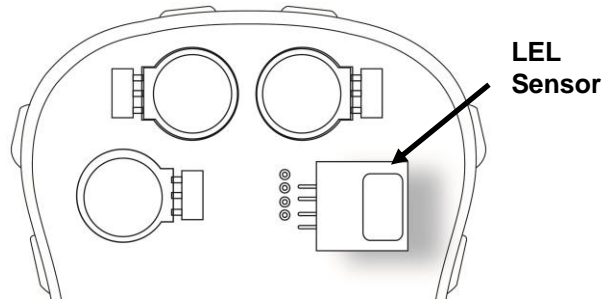

13.2. Replacing Sensors

1. Install the replacement sensor. Make sure the electrical contact pins are aligned with the holes in the PC board and that the sensor is seated firmly.
2. Remove the plastic film from the top of the sensor.
3. Replace the cover and tighten the four screws.

WARNING!

It is extremely important that sensors are installed in the correct orientation.

When installing a new sensor, the plastic film should be on top of the sensor. Once the sensor is installed, remove the plastic film.

IMPORTANT! Always perform a full calibration after replacing sensors.

13.3. Replacing The LEL Filter

If the LEL sensor appears dirty, it should be replaced with a new one (H₂S filter P/N: 014-3603-005, package of 5; or H₂S & Si filter P/N: 014-3604-005, package of 5).

1. Remove the LEL filter from the gasket and dispose of it.
2. Replace the LEL sensor in its place in the gasket.

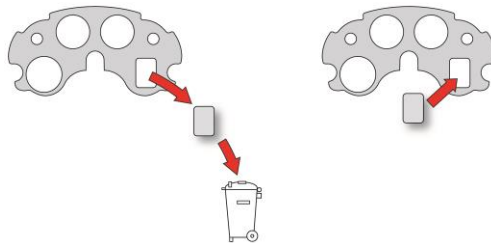

13.4. Replacing The Battery

WARNING! Do not replace the battery in a hazardous location. Use only RAE Systems battery P/N: M03-3004-000.

13.4.1 Removing The Battery

The battery is located inside the MicroRAE, attached to the backside of the printed circuit board.

To access and replace the battery:

1. After opening the instrument, lift off the front cover from the back.
2. Remove the two screws that secure the printed circuit board.
3. Tilt up the printed circuit board from the top. There is a ribbon cable connecting the printed circuit board and the back, so be careful not to damage it.
4. Remove the two screws holding the battery in place.
5. Lift the battery straight up to remove it.
6. Properly dispose of the old battery.

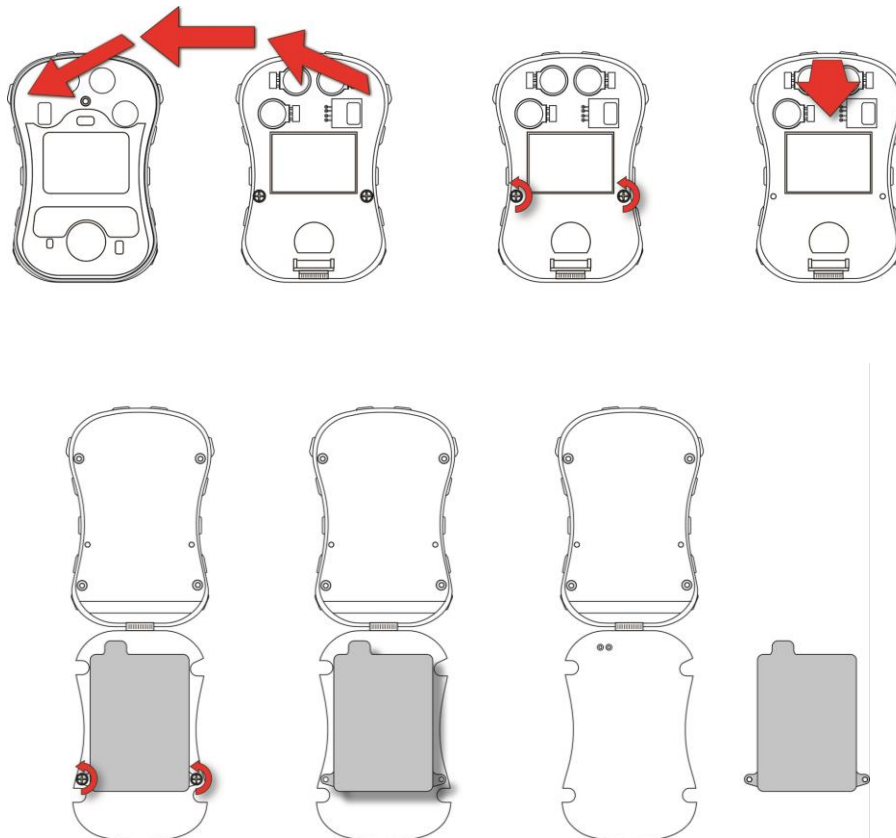

MicroRAE User's Guide

13.4.2 Installing The New Battery

When you reassemble the MicroRAE, inspect for any damage and make sure the sealing rib is in place.

1. Position the new battery so that its two screw holes are aligned over the screw holes in the printed circuit board, and the protruding part of the battery is aligned over the two power pins that stick up from the printed circuit board.
2. Replace the two screws to secure the battery in place. Do not overtighten.
3. Gently flip the printed circuit board up so that it turns over and sits in the case bottom.
4. Replace the two screws to secure the printed circuit board in place. Do not overtighten.

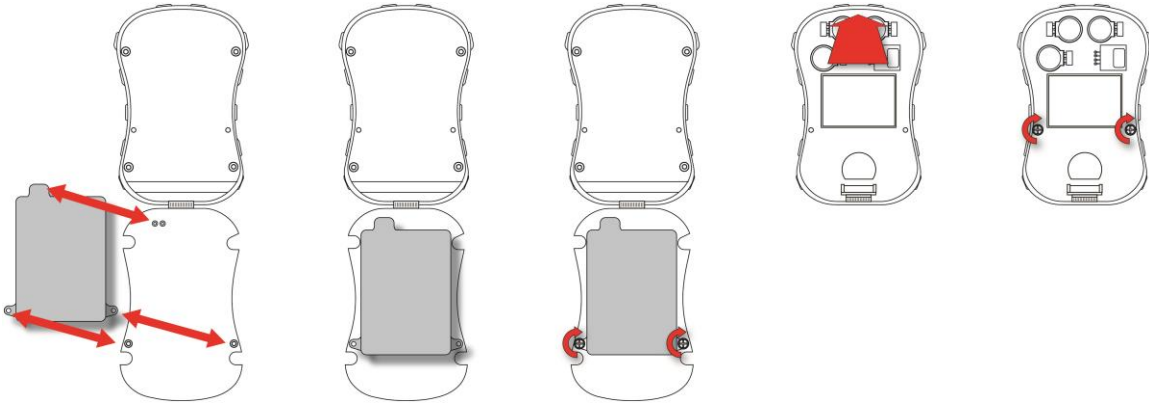

13.5. Reassembling The MicroRAE

When you reassemble the MicroRAE, inspect for any damage and make sure the sealing rib is in place and that you use new O-rings for the four screws. (Screws and O-rings, package of 10, P/N: M03-3010-000.)

Important! If the housing is damaged, it should be replaced. Contact RAE Systems customer service.

Before mating the front and back housings, make sure the Sealing Rib is in position and not cracked, damaged, or distorted:

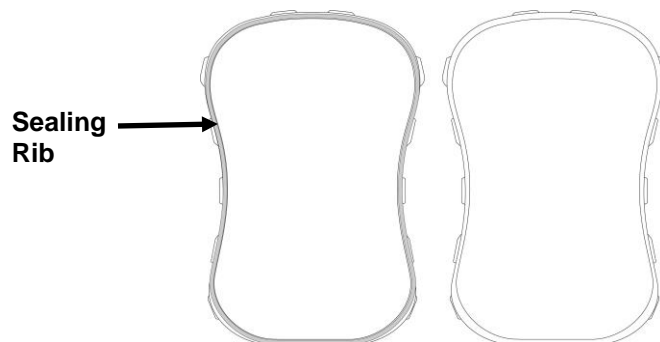

MicroRAE User's Guide

The four screws that hold the housing together must have new O-rings (PN: 430-B074-060) installed to help ensure that water and debris do not enter through the screw access points.

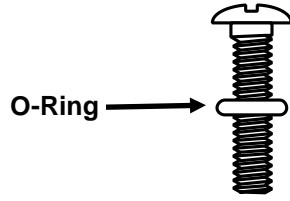

To prevent damage to the housing, the screw, and the O-ring, an electric screwdriver should be set with torque less than 3kgf.cm, and a speed rate of less than 670r/min.

Tighten the screws following this order:

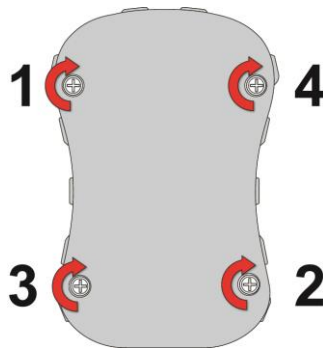

14. Alarms Overview

The MicroRAE provides an unmistakable five-way alarm notification system that combines local alarms on the device with real-time remote wireless alarm notification to enhance worker. Local alarms include audible buzzer alarm, visible alarm via bright LED lights, vibration alarm, and an alarm notification on the display. These can be programmed or selectively turned on or off.

14.1. Alarm Signals

During each measurement period, the gas concentration is compared with the programmed alarm limits for Low, High, TWA and STEL alarm. If the concentration exceeds any of the preset limits, the alarms are activated immediately to warn both the MicroRAE user and a remote safety officer (if wireless is enabled) of the alarm condition.

In addition, the MicroRAE alarms if the battery voltage is low.

When the low battery alarm occurs, there may be approximately 10 minutes of operating time remaining. In this case, it is recommended that you promptly charge the battery in a non-hazardous location.

Note: The default setting for the alarms is “unlatched.” To change this to latched mode, you must use ProRAE Studio II software.

MicroRAE User's Guide

14.2. Alarm Signal Summary

Alarm Summary

Alarm Type	Buzzer & LED	Display	Vibration	Reading	Backlight	Priority
Super Alarm	4 beeps/sec	“Man Down Alarm” screen	400ms	-	On	Highest
Man Down Alarm	3 beeps/sec	“Man Down Alarm” screen	400ms	-	On	
Man Down Warning	2 beeps/sec	“OK” screen	400ms	-	On	
Max	3 beeps/sec	“MAX” at sensor location, ALARM icon on	400ms	Blinking reading	On	
Over Range	3 beeps/sec	“Over” at sensor location, ALARM icon on	400ms	Blinking maximum reading	On	
High	3 beeps/sec	“HIGH” at sensor location, ALARM icon on	400ms	Blinking reading	On	
Low	3 beeps/sec	“LOW” at sensor location, ALARM icon on	400ms	Blinking reading	On	
Negative	1 beep/sec	“NEG” at sensor location, ALARM icon on	400ms	Blinking “0”	On	
STEL	1 beep/sec	“STEL” at sensor location, ALARM icon on	400ms	Blinking reading	On	
TWA	1 beep/sec	“TWA” at sensor location, ALARM icon on	400ms	Blinking reading	On	
Calibration Failure	1 beep/sec	“CAL” at sensor location, ALARM icon on	400ms	Blinking reading	On	
Bump Failure	1 beep/sec	“Bump” at sensor location, ALARM icon on	400ms	Blinking Reading	On	
Datalog Full	1 beep/sec	Blinking datalog symbol	400ms	Reading	On	
Calibration Due	-	“CAL” at sensor location	-	Blinking Reading	-	
Bump Test Due	-	“Bump” at sensor location	-	Blinking Reading	-	
Battery	1 beep/min	Blinking battery icon	400ms	Reading	Stays as is	
Network Lost	1 beep/sec	Blinking radio icon	400ms	Reading	On	
Network Joined	1 beep	Radio icon	400ms	Reading	-	
Comfort Beep	1 beep/min No LED flash	-	-	Reading	-	Lowest

Notes

- “Negative” means that the reading is below zero.
- “Network Lost” means that the MicroRAE has lost wireless connectivity with its network.
- “Network Joined” means that the MicroRAE has joined a wireless network.
- “CAL” includes Span calibration failure, Zero/fresh air calibration failure.
- Zero/fresh air failure is only supported by LEL and oxygen sensors.

MicroRAE User's Guide

General Alarms

Alarm Type	Buzzer & LED	Display	Vibrator	Reading	Backlight	Priority
Oxygen Low Low	3 beeps/second	“LOW” Oxygen sensor on display	400ms	-	On	Highest
Low Alarm	3 beeps/sec	“LOW” at sensor location, ALARM icon on	400ms	Blinking reading	On	
LEL failure	3 beeps/second	“FAIL” LEL sensor on display	400ms	-	On	
Confidence LED flash	Blinking Confidence LED for 3 seconds	“OK” on display	-	-	-	
GPS Offline	-	Blinking “GPS” icon	-	-	-	Lowest

* For oxygen, “LOW Oxygen” means a concentration is lower than the low alarm limit.

14.1. Manual Alarms Test

Under Normal Operation Mode and non-alarm conditions, the buzzer (audible alarm), vibration, visible alarms, and backlight can all be tested anytime by pressing [Y/+]. If any alarm does not respond, connect the MicroRAE to a PC running ProRAE Studio II and check the alarm settings to make sure all alarms are enabled. If any alarms are enabled but not functional, the instrument should not be used. Contact RAE Systems Technical Support.

15. Troubleshooting

Problem	Possible Reasons & Solutions
Cannot turn on power after charging the battery	<p>Reasons: Defective charging circuit. Defective battery.</p> <p>Solutions: Try charging the battery again. Replace battery or charger.</p>
Lost password	<p>Solutions: Call Technical Support at +1 408-952-8461 or toll-free at +1 888-723-4800</p>
Buzzer, LED lights, and vibration motor inoperative	<p>Reasons: Buzzer and/or other alarms disabled. Bad buzzer.</p> <p>Solutions: Check under “Alarm Settings” in Programming Mode that buzzer and/or other alarms are not turned off. Call authorized service center.</p>

If you need replacement parts, please contact an authorized RAE Systems distributor.

16. Diagnostic Mode

In Diagnostic Mode, the MicroRAE provides raw counts for sensor, battery, and other readings, as well as a list of installed sensors and information about them (expiration date, serial number, etc.). Most of these screens are useful only to service technicians. Many allow access for changing settings.

The MicroRAE's Diagnostic Mode can only be accessed at startup time. In Diagnostic Mode, MicroRAE displays readings in raw counts instead of units such as parts per million (ppm) or other units of measure.

16.1. Entering Diagnostic Mode

1. With the MicroRAE turned off, press and hold both [MODE] and [Y/+].
2. When the display turns on and the password screen appears, release the keys.
3. Enter the 4-digit password (the password is the same as the one for the Programming Mode; the default password is 0000).
 - Step from one position in the four-character string to the other by pressing [MODE].
 - Press [Y/+] repeatedly to select a desired number. Numbers increase from 0 to 9.
 - Once 9 is reached, pressing [Y/+] again “wraps” around back to 0.
4. When you are done, press [MODE] followed by [Y/+]. If you input the correct password, the instrument restarts in normal reading mode.

16.2. Exiting Diagnostic Mode

1. Turn off the MicroRAE by pressing and holding [MODE]. There will be a standard shutoff countdown.
2. When the instrument shuts off, you will be alerted. Release your finger.

Note: The next time you start MicroRAE, hold only [MODE], and it will automatically start in Normal Mode.

16.3. Navigating Diagnostic Mode

Step through Diagnostic Mode by pressing [MODE]. The first screen you see is information about the product, including the serial number, firmware version, etc. Exit Diagnostic Mode at any time by shutting the instrument off (hold [MODE] for the 5-second countdown).

- Instrument model name and ID number (in hexadecimal)
- Serial number
- Instrument firmware Version
- Firmware build date
- Firmware build time
- Sensors Installed
- Socket Raw Counts (for all installed sensors)
- Zero and Span raw counts for LEL sensor
- Zero and Span raw counts for O2 sensor
- Air and Span raw counts for O2 sensor
- Location 1 Zero and Span raw counts
- Location 2 Zero and Span raw counts
- LEL sensor ID and Gain (press [Y/+] to step through raw count and last calibration date and time)
- O2 sensor ID and Gain (press [Y/+] to step through raw count and last calibration date and time)
- Location 1 ID and Gain (press [Y/+] to step through raw count and last calibration date and time)
- Location 2 ID and Gain (press [Y/+] to step through raw count and last calibration date and time)
- Buzzer Mode (press [Y/+] to change: 0 = silent, 1 through 7 indicates number of beeps per second)
- Buzzer Frequency (press [Y/+] to change frequencies in 100 Hz increments)
- Battery voltage (raw count; press [Y/+] to view VRAW and voltage)
- RTC (real-time clock) shows date and time
- Ambient light sensor threshold raw count (press [Y/+] to turn backlight on/off)
- Backlight and Vibrator (press [Y/+] to toggle; BKL1 = white backlight, BKL2 = red backlight)
- Temperature raw count and Celsius reading
- Motion (shows X, Y, and Z position; press [Y/+] to change window, warning time, and threshold value)
- Runtime
- LCD contrast (press [Y/+] to change)
- LCD Test (press [Y/+] to show entire display)
- BLE (Bluetooth Low Power) power on (on/off status, press [Y/+] for MAC address)
- GPS Power (if GPS is installed)
- WiFi (press [Y/+] to step through settings)
- GPS longitude and latitude (press [Y/+] to show status and number of satellites)
- Mesh module firmware version and build date (press [Y/+] to show ID, PANID, Press [Y/+] to continue to show PID and channel, and press [Y/+] again to show region and radio type)
- Communication – Enter communication mode with computer (press [Y/+] to enter; press [MODE] to exit)

MicroRAE User's Guide

17. Editing Features

Some features can be turned on or off or edited directly on the MicroRAE, some can only be accessed through ProRAE Studio II, and some can be accessed and changed through both. The table below shows where features can be accessed.

Feature	MicroRAE	ProRAE Studio II
Single Bump	✓	
Single Zero	✓	
Single Span	✓	
Multi Bump	✓	
Fresh Air Calibration	✓	
Multi Span	✓	
Set LEL Calibration Gas		✓
Set Span		✓
Sensor On/Off	✓	✓
Set LEL Measurement Gas		✓
Set Alarm Limits		✓
Set Alarm Mode		✓
Alarm Settings		✓
Comfort Beep		✓
Man Down Alarm On/Off		✓
Man Down Alarm Motionless Time		✓
Man Down Sensitivity		✓
Man Down Alarm Warning Time		✓
Clear Datalog	✓	✓
Datalog Interval		✓
Datalog Sensor Selection		✓
Datalog Data Selection		✓
Datalog Type		✓
Datalog Action When Full		✓
Glance Mode Enable		✓
Set Date		✓
Set Time		✓
Backlight		✓
Set Site ID	✓	✓
Set User ID	✓	✓
User Mode		✓
Zero At Start		✓
Radio On/Off	✓	✓
Set PAN ID	✓	✓
Set Channel	✓	✓
Join Network	✓	✓
Set Wireless Interval		✓
Off Network Alarm		✓
Wireless Factory Reset	✓	

Continued on next page

MicroRAE User's Guide

Editing Features, continued

Feature	MicroRAE	ProRAE Studio II
GPS On/Off	✓	✓
GPS Recover Mode Period		✓
BLE On/Off	✓	✓
WiFi On/Off	✓	✓
Set Access Point SSID		✓
Set Access Point Password		✓
DHCP Enable		✓
Set Server IP Address		✓
Set Server Port		✓
Confidence LED interval		✓
Get/Set bump test date and interval		✓
Get/Set calibration test date and interval		✓
Get/Set sensor maintenance		✓
Get/Set sensor to log		✓
Set Glance Mode screen		✓
Roaming On/Off		✓
GPS Search Mode Period		✓
Get BLE MAC address		✓
Get/Set BLE PIN code		✓
Set WiFi MAC address		✓
Get/Set WiFi message		✓
Get gas library information		✓
Get/Set custom gas list		✓
Get/Set password		✓
Get last run time		✓
Get/Set LCD contrast		✓



18. Specifications

Instrument Specifications

Size	4.6" x 3.0" x 1.1" (117 mm x 76 mm x 27 mm)
Weight	7 oz (200 g)
Sensors	Four sensors, including electrochemicals for toxics and oxygen, combustible LEL
Battery Options	Rechargeable Li-ion: 15 hours continuous without wireless and no alarms; 12 hours continuous with wireless and no alarms Note: All battery specifications at 20° C; lower temperatures might affect runtime.
Display	<ul style="list-style-type: none"> • Monochrome graphic display with backlighting (activated automatically in dim ambient lighting conditions, when monitor is in alarm, or with a key press); backlight can be white or red (selectable)
Display Readout	<ul style="list-style-type: none"> • Real-time reading of gas concentrations; battery status; datalogging on/off; wireless on/off and wireless reception quality. • STEL, TWA, peak, and minimum values • Man Down and policy enforcement indicators • GPS quality indicator (if GPS equipped)
Keypad	2 operation and programming keys (MODE and Y/+)
Sampling	Diffusion
Calibration	Manual
Alarms	<ul style="list-style-type: none"> • Wireless remote alarm notification; audible, vibration, visible (flashing bright red LEDs), and on-screen indication of alarm conditions • Man Down Alarm with real-time remote wireless notification
Datalogging	<ul style="list-style-type: none"> • Continuous datalogging (six months for four sensors at 1-minute intervals, 24/7) • User-configurable datalogging interval (from 1 to 3,600 seconds)
Communication and Data Download	<ul style="list-style-type: none"> • Data download and instrument set-up and upgrades on PC via charging and Travel Charger • Wireless data and status transmission via built-in RF modem (optional)
Wireless Connectivity	BLE (Bluetooth Low Energy) plus optional RAE Systems Dedicated Wireless Network and closed-loop systems or WiFi
Wireless Frequency	ISM license-free band, 868Mhz or 900MHz
Wireless Approvals	FCC Part15, CE R&TTE, ANATEL
Wireless Range (Typical)	EchoView Host & MicroRAE: Line of sight >200m (650 ft), receiving data >80% ProRAE Guardian & Mesh Reader & MicroRAE: Line of sight >200m (650 ft), receiving data >80% ProRAE Guardian & RAELink3 & MicroRAE: Line of sight >100m (330 ft), receiving data >80%

Continued

MicroRAE User's Guide

Instrument Specifications	
<i>continued</i>	
Operating Temperature	-4° to 140° F (-20° to 60° C)
Humidity	0% to 95% relative humidity (non-condensing)
IP Rating	IP-67
Hazardous Location Approvals	USA and Canada: classified for use in Class I, Division 1, Groups A, B, C and D T-Code T4 Global: IECEx: Ex ia d IIC T4 Gb; Ex ia I Ma Europe: ATEX:  II 2G Ex ia d IIC T4 Gb;  I M1 Ex ia I Ma
CE Compliance (European Conformity)	2004/108/EC (EMC) 1999/5/EC (Radio) 94/9/EC (ATEX)
FCC Compliance	FCC Part 15
Languages	English
Warranty	<ul style="list-style-type: none"> • Two years on LEL, CO, H₂S, and O₂ sensors • One year on other sensors

Specifications are subject to change.

Sensor Specifications

Combustible Sensor	Range	Resolution	Operating Temperature
Catalytic bead LEL	0 to 100% LEL	1% LEL	-4° to 122° F (-20° to 50° C)
Electrochemical Sensors	Range	Resolution	Operating Temperature
Carbon Monoxide (CO)	0 to 250 ppm 251 to 1000 ppm	1 ppm 3 ppm	-4° to 122° F (-20° to 50° C)
Hydrogen Cyanide (HCN)	0 to 50 ppm	0.2 ppm	-4° to 122° F (-20° to 50° C)
Oxygen (O ₂)	0 to 30% Vol.	0.1% Vol.	-4° to 122° F (-20° to 50° C)
Hydrogen Sulfide (H ₂ S)	0 to 50 ppm 51 to 100 ppm	0.1 ppm 1 ppm	-4° to 122° F (-20° to 50° C)

All specifications are subject to change without notice.

LEL Range, Resolution & Response Time

Range

0 to 100% LEL

Resolution

1%

Response Time:

T₉₀ < 30 sec.

Caution:

- Refer to RAE Systems Technical Note TN-114 for LEL sensor cross-sensitivities.
- Refer to RAE Systems Technical Note TN-144 for LEL sensor poisoning.

MicroRAE User's Guide

Year Of Manufacture

To identify the year and month of manufacture, refer to the two digit marking placed adjacent to the serial number on the instrument label according to the following table:

Year	First digit Year code	Month	Second digit Month code
2014	R	January	1
2015	S	February	2
2016	T	March	3
2017	U	April	4
2018	V	May	5
2019	W	June	6
2020	A	July	7
2021	B	August	8
2022	C	September	9
2023	D	October	A
2024	E	November	B
2025	F	December	C

Example: “RA” indicates that the monitor is manufactured in the month of October in the year 2014.

Model Designations And Base Configuration

Model Name	Configuration
PGM-2600	MicroRAE with BLE
PGM-2601	MicroRAE with BLE/Mesh Radio
PGM-2602	MicroRAE with BLE/WiFi

Standard Span Values For Sensors

Sensor	Standard Span Values
CO	50 ppm
H ₂ S	10 ppm
OXY	18.0 %
LEL	50 %LEL Methane
HCN	10 ppm

MicroRAE User's Guide

Sensor Parameters Edit Range

Parameter	Unit	Minimum	Maximum	Default
CO Span	ppm	1	500	50
CO Range	ppm	1	1000	N/A
CO Low	ppm	1	1000	35
CO High	ppm	1	1000	200
CO STEL	ppm	1	1000	100
CO TWA	ppm	1	1000	35
H ₂ S Span	ppm	1	100	10
H ₂ S Range	ppm	1	100	N/A
H ₂ S Low	ppm	1	100	10
H ₂ S High	ppm	1	100	20
H ₂ S STEL	ppm	1	100	15
H ₂ S TWA	ppm	1	100	10
LEL Span	%LEL	1	100	50
LEL Range	%LEL	1	100	N/A
LEL Low	%LEL	1	100	10
LEL High	%LEL	1	100	20
O ₂ Span	%	1	30	18
O ₂ Range	%	1	30	N/A
O ₂ Low	%	1	30	19.5
O ₂ High	%	1	30	23.5
O ₂ Low Low	%	1	30	17
HCN Span	ppm	1	50	10
HCN Range	ppm	1	50	N/A
HCN Low	ppm	1	50	4.7
HCN High	ppm	1	50	25

19. Controlled Part of the Manual for PGM-26XX

SAFETY INSTRUCTIONS

Read Before Operating

This Manual must be carefully read by all individuals who have or will have the responsibility of using, maintaining, or servicing this product. The product will perform as designed only if it is used, maintained, and serviced in accordance with the manufacturer's instructions. The user should understand how to set the correct parameters and interpret the obtained results.

FOR SAFETY REASONS, THIS EQUIPMENT MUST BE OPERATED AND SERVICED BY QUALIFIED PERSONNEL ONLY.

CAUTION!

The PGM-26XX shall only be charged using a charger specifically supplied for use with the unit (for example part number 3A-066WPxx or 3A-401WP12, manufactured by ENG Electric), approved as SELV or Class 2 equipment against IEC 60950 or an equivalent IEC standard. The maximum voltage from the charger shall not exceed 6.0 VDC.

Likewise, any data download device connected to the PGM-26XX shall also be approved SELV or Class 2 equipment.

Use of non-RAE Systems components will void the warranty and can compromise the safe performance of this product.

MicroRAE User's Guide

PGM26XX Marking

The PGM-26XX is certified according to the IECEx scheme, ATEX and CSA for US and Canada as protected by intrinsic safety.

The PGM-26XX is certified according to the IECEx scheme, ATEX and CSA for US and Canada under the intrinsic safety method of protection.

The PGM-26XX is marked with the following information:





RAE SYSTEMS

3775 N. 1st. St., San Jose

CA 95134, USA

Type PGM-26XX

Serial No/barcode: XXXX-XXXX-XX

IECEX SIR 15.0039X Ex ia d IIC T4 Gb Ex ia I Ma	 SIRA 15 ATEX 2080X  II 2G Ex ia d IIC T4 Gb  I M1 EX ia I Ma	 Cl. I Div. 1, Grps A,B,C,D T-Code T4. C22.2 No.152-M1984 ANSI/ISA-12.13.01-2000 Intrinsically safe/Sécurité intrinsèque
Applied standards (ATEX-IECEX)		
IEC 60079-0:2011 IEC 60079-1:2014-06 IEC 60079-11:2011	EN 60079-0:2012/A11:2013 EN 60079-1:2014 EN 60079-11:2012	See list for applied requirements for cCSAus in the table below.

APPLICABLE REQUIREMENTS (cCSAus)

CAN/CSA-C22.2 No. 60079-0:2011 (IEC 60079-0:2007, MOD)	Explosive atmospheres — Part 0: Equipment — General requirements
CAN/CSA-C22.2 No. 60079-11:2014 (IEC 60079-11:2011, MOD)	Explosive atmospheres — Part 11: Equipment protection by intrinsic safety “i”
CAN/CSA-C22.2 No. 30-M1986	Explosion-Proof Enclosures for Use in Class I Hazardous Locations
CAN/CSA-C22.2 No. 152-M1984	Combustible Gas Detection Instruments
CAN/CSA C22.2 No. 61010-1-12	Safety Requirements for Electrical Equipment for Measurement, Control, and Laboratory Use - Part 1: General Requirements - Third Edition
UL 60079-0:2013 (6th Ed.)	Explosive atmospheres — Part 0: Equipment — General requirements
UL 60079-11:2013 (6th Ed.)	Explosive atmospheres — Part 11: Equipment protection by intrinsic safety “i”
UL 913 (7th Ed.)	Intrinsically Safe Apparatus and Associated Apparatus for Use in Class I, II and III, Division 1, Hazardous Locations
UL 1203 (4th Ed.)	Explosion-Proof and Dust-Ignition-Proof Electrical Equipment for Use in Hazardous (Classified) Locations
ANSI/ISA 12.13.01-2000	Performance Requirements for Combustible Gas Detectors
ANSI/ISA-61010-1 (3rd Ed.)	Safety Requirements for Electrical Equipment for Measurement, Control, and Laboratory Use - Part 1: General Requirements - Third Edition

MicroRAE User's Guide

-20° C < Tamb < +60° C;

Um: 6V

Battery pack: M03-3004-000

Warning: Substitution of components may impact intrinsic safety

Avertissement: La substitution de composants peut compromettre la sécurité intrinsèque

**CAUTION: READ AND UNDERSTAND INSTRUCTION MANUAL BEFORE
OPERATING OR SERVICING**

**ATTENTION: LIRE ET COMPRENDRE MANUEL D'INSTRUCTIONS AVANT
D'UTILISER OU SERVICE**

Operation Area and Conditions

Hazardous Areas classified by Zones

PGM-26XX are intended to be used in hazardous areas classified Zone 1 or Zone 2 within the temperature range of -20°C to +60°C, where gases of explosion groups IIA, IIB or IIC and T4 may be present, and in underground mines endangered by firedamp.

Hazardous Areas classified by Divisions

PGM-26XX is intended to be used in hazardous areas classified for Class I Div. 1 or 2, within the temperature range of -20° C to +60° C, where gases of explosion groups A, B, C or D and temperature code T4 may be present.

Instruction For Safe Use

WARNING: Read and understand instruction manual before operation or servicing.

AVERTISSEMENT: Lisez et comprenez le manual d'instructions avant d'utiliser ou service.

WARNING: Substitution of components may impact intrinsic safety.

AVERTISSEMENT: La substitution de composants peut compromettre la sécurité intrinsèque

WARNING: To prevent ignition of a hazardous atmosphere, batteries must only be charged in an area known to be non-hazardous. Um = 6.0V. Use only approved charger/

AVERTISSEMENT: Afin de prevenir l'inflammation d'atmosphères dangereuse, ne charger le jeu de batteries que dans des emplacement designés non dangereux. Um = 6V
Utilisez uniquement un chargeur approuvé.

Only use approved battery pack: M03-3004-000

Only charge the battery in safe area in the ambient temperature range $0^{\circ}\text{C} \leq T_{\text{amb}} \leq 40^{\circ}\text{C}$

EMI may cause mis-operations.

Use In Hazardous Areas

Equipment intended for use in explosive atmospheres and which has been assessed and certified according to international regulations may be used only under specified conditions. The components may not be modified in any way.

The appropriate regulations for service and repair must be properly observed during such activities.

MicroRAE User's Guide

Year of manufacture

To identify the year and month of manufacture, refer to the two digit marking placed adjacent to the serial number on the instrument label according to the following table:

Year	First digit Year code	Month	Second digit Month code
2014	R	January	1
2015	S	February	2
2016	T	March	3
2017	U	April	4
2018	V	May	5
2019	W	June	6
2020	A	July	7
2021	B	August	8
2022	C	September	9
2023	D	October	A
2024	E	November	B
2025	F	December	C

E.G.: "RA" indicates that the monitor is manufactured in the month of October in the year 2014.

20. Technical Support

To contact RAE Systems Technical Support:

Monday through Friday, 7:00AM to 5:00PM Pacific (US) Time

Phone (toll-free): +1 877-723-2878

Phone: +1 408-952-8200

Fax: +1 408-952-8480

Email: RAE-tech@honeywell.com

21. RAE Systems Contacts

RAE Systems by Honeywell World Headquarters

3775 N. First St.

San Jose, CA 95134-1708 USA

Phone: +1 888-723-4800

E-mail: RAE-tech@honeywell.com

Web Site: www.raesystems.com

Training

Phone: +1 408-952-8260

Email: training@raesystems.com

Outside the Americas:

E-Mail: HZexpert@honeywell.com

Honeywell Analytics Ltd.

4 Stinsford Road

Nuffield Industrial Estate

Poole, Dorset, BH17 0RZ

United Kingdom

Tel: +44 (0) 1202 645 544

Fax: +44 (0) 1202 645 555

Honeywell Analytics

Elsenheimerstrasse 43

80687 München

Germany

Tel: +49 89 791 92 20

Fax: +49 89 791 92 43

Honeywell Analytics

ZAC Athélia 4 – 375 avenue du Mistral

Bât B, Espace Mistral

13600 La Ciotat

France

Tel: +33 (0) 4 42 98 17 75

Fax: +33 (0) 4 42 71 97 05

Honeywell Analytics

P.O. Box-45595

6th Street

Musaffah Industrial Area

Abu Dhabi

UAE

Tel: +971 2 554 6672

Fax: +971 2 554 6672



MicroRAE

User's Guide

**environmental
SCIENCE**

AND TECHNOLOGY

www.environst.com

info@environst.com

+44(0)1904 373 018

CORPORATE HEADQUARTERS

RAE Systems by Honeywell

3775 North First Street

San Jose, CA 95134 USA

Phone: 408.952.8200

Fax: 408.952.8480

RAE-tech@honeywell.com

WORLDWIDE SALES OFFICES

USA/Canada 1.877.723.2878

Europe +800.333.222.44/+41.44.943.4380

Middle East +971.4.450.5852

China +86.10.5885.8788-3000

Asia Pacific +852.2669.0828